

版次	变更摘要	日期
0	新产品发行	2017/09/06

序号	品名	材质
①	2.00 F型立式2代WTB胶芯	LCP UL94V-0 本色
②	2.00 F型卧式2代WTB端子	铜合金/表面镀锡
③	2.00 F型立式2代WTB焊片	铜合金/表面镀锡
④	2.00 F型立式2代WTB吸盖	LCP UL94V-0 本色

- 技术指标:
1. 工作温度: $-25^{\circ}\text{C} \sim 85^{\circ}\text{C}$.
 2. 额定电压: 200V DC/AC(rms).
 3. 额定电流: 2.0A AC, DC.
 4. 接触电阻: $\leq 20\text{m}\Omega$.
 5. 耐压值: 500V AC/minute.
 6. 绝缘电阻: $\geq 1000\text{M}\Omega$.
 7. 产品料号:

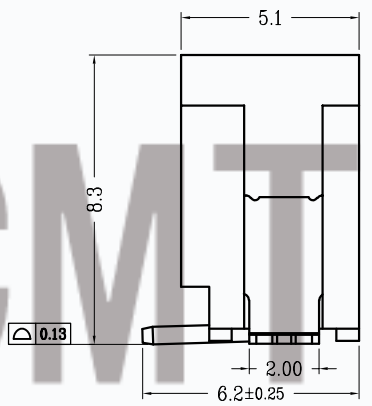
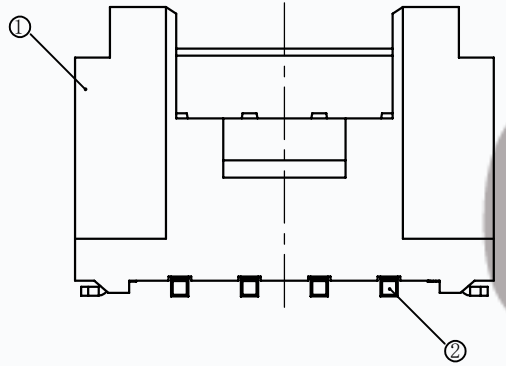
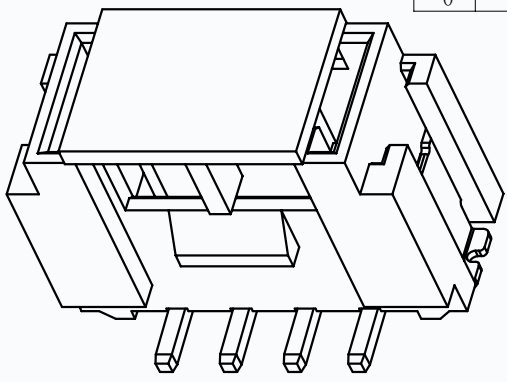
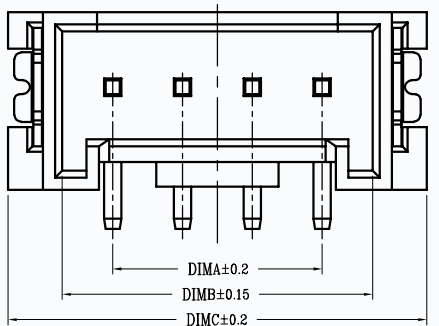

T19-20FLB-***-2*

NO OF CKT (产品PIN数) 胶芯有LOGO:TD

Plating (电镀方式) 胶芯无LOGO

Packing (包装方式)

- T: TUBE管装
- R: TAPE & REEL 卷装
- C: TAPE & REEL WITH COVER加吸盖卷装

CKT	DIM A	DIM B	DIM C
2	2.00	4.90	8.00
3	4.00	6.90	10.00
4	6.00	8.90	12.00
5	8.00	10.90	14.00
6	10.00	12.90	16.00
7	12.00	14.90	18.00
8	14.00	16.90	20.00
9	16.00	18.90	22.00
10	18.00	20.90	24.00
11	20.00	22.90	26.00
12	22.00	24.90	28.00
13	24.00	26.90	30.00
14	26.00	28.90	32.00
15	28.00	30.90	34.00
16	30.00	32.90	36.00
17	32.00	34.90	38.00
18	34.00	36.90	40.00
19	36.00	38.90	42.00
20	38.00	40.90	44.00

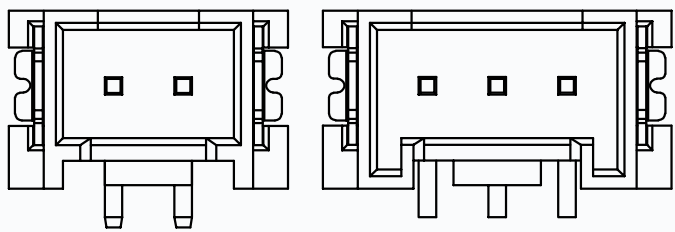
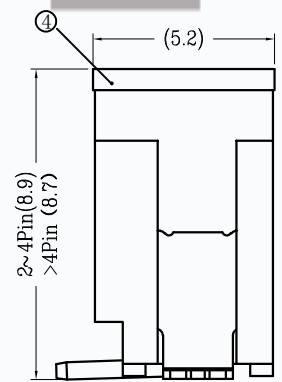
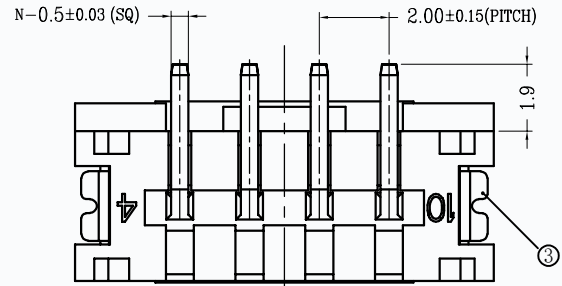

2 PIN 结构样式

3 PIN 结构样式

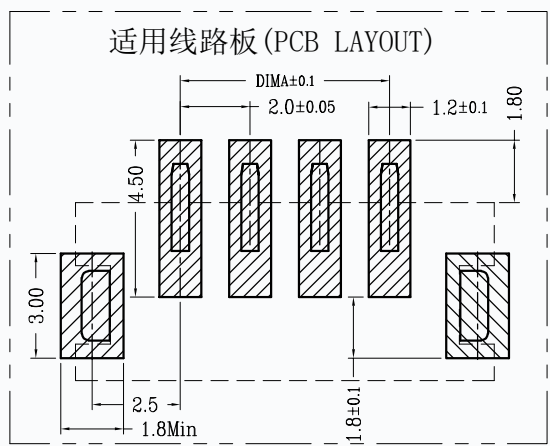

适用线路板 (PCB LAYOUT)



一般公差 (TOLERANCE)

X ±.50 .XX ±.10

X ±.20 .XXX ±.05

ANGLES ±1°

CMTDDZ 东莞市田都科技有限公司
Dongguan TianDu Technology Co. Ltd.

品名 (TITLE)	2.00 Pitch F型立式2代WTB	制图 (DR)	ERIC
料号 (DWG.NO)	T19-20FLB-****-2*	校对 (CHKD)	
比例 (SCALE)	1:1	审核 (APPD)	
单位 (UNITS)	mm	张数 (SHEET)	1 OF 1
		SIZE	A4
		REV	A