

RoHS

REV.	DESCRIPTION	APPD	DATE

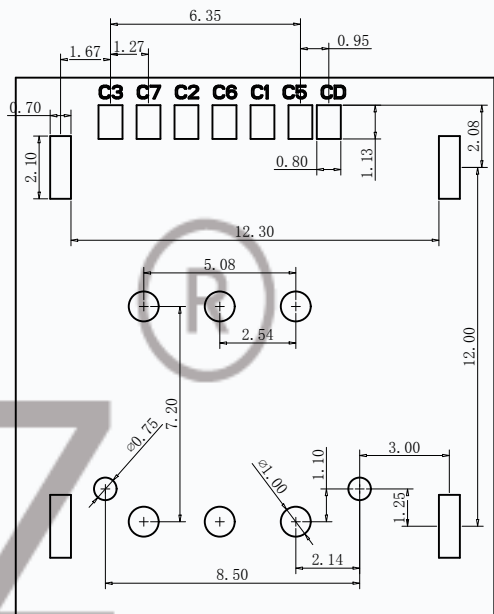
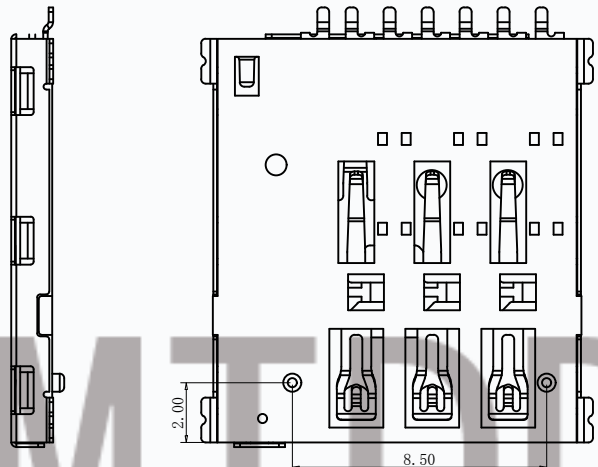
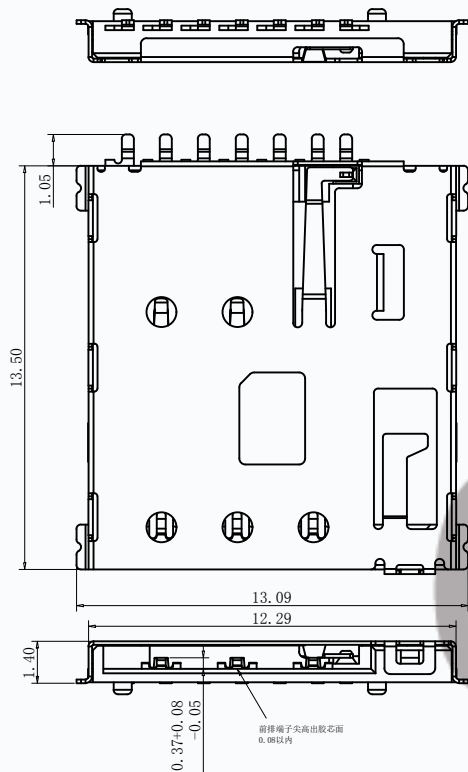

- 1) MATERIAL:  
HOUSING: LCP S475 UL 94V-0  
CONTACT: C5210R-H  
SHELL: SUS304-H
- 2) FINISH:  
CONTACT: GOLD FLASH PLATED ON CONTACT AREA;  
GOLD FLASH PLATED ON SOLDER TAILS,
- 3) ELECTRICAL CHARACTERISTICS  
RATING CURRENT : 0.5A MAX.  
CONTACT RESISTANCE : 50 mΩ MAX  
DIELECTRIC WITHSTANDING : 500V AC MIN.  
INSULATION RESISTANCE: 1000 MΩ MIN.
- 4) MECHANICAL CHARACTERISTICS  
MATING CYCLE : 3000 CYCLES

SIM pin Assignment	
PIN#	Name
C1	VCC
C2	RST
C3	CLK
C5	GND
C6	VPP
C7	I/O

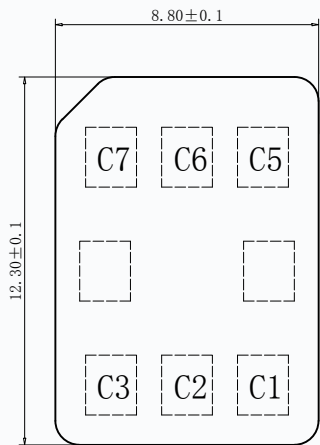

T14-07NS-140H-7P-\*

- 1 有柱
- 2 无柱

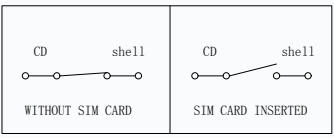

PART NO: T14-07NS-140H-7P		MATERIAL:		<b>CMTDDZ 东莞市田都科技有限公司</b> Dongguan TianDu Technology Co. Ltd.
LOT NO:		FINISH:		
UNIT: MM	SIZE: A4	COLOR:		TITLE: NANO SIM PUSN 卡座
TOLERANCES: X. X=±0.35 X. XX=±0.25 X. XXX=±0.15		GENERAL ANGLE: X. X=±3.0° X. XX=±2.0°		DR: ERIC
APP:		CHK:	DWG NO:	REV: A
SCALE: 1:1		SHEET: 1 OF 1		

RoHS

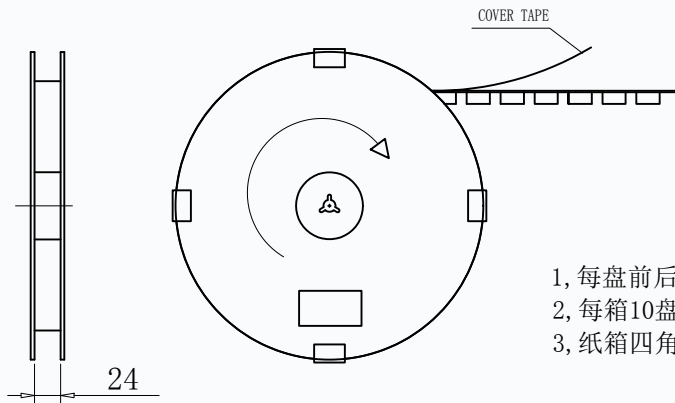
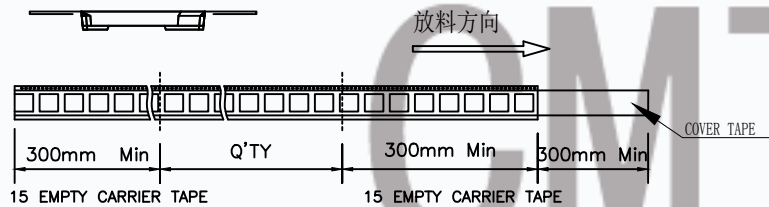
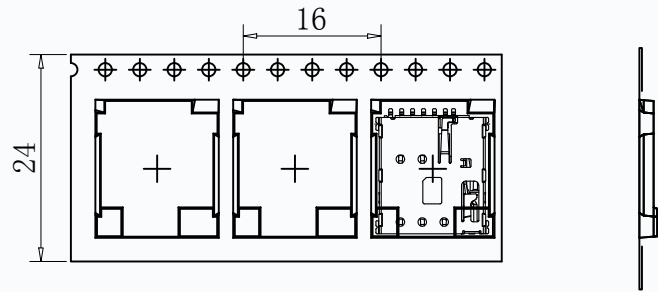

- 1, 每盘前后空5PSC, 中间包装1500PCS
- 2, 每箱10盘, 共15000PCS。
- 3, 纸箱四角放脚柱。

QTY/REEL	REEL/CARTON	QTY/CARTON
1500	10	15000

REV.	DESCRIPTION	APPD	DATE

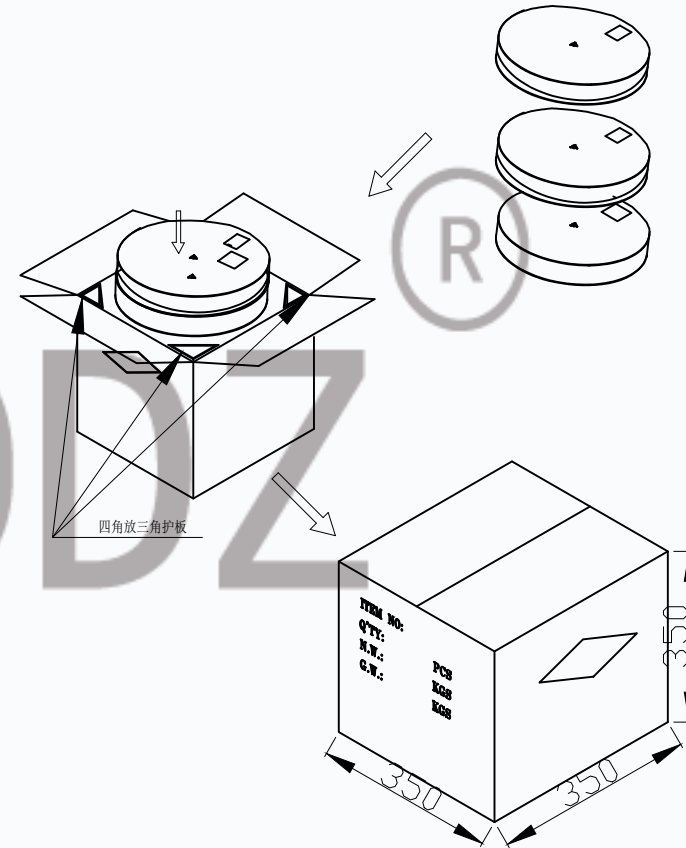

PART NO: T14-07NS-140H-7P		MATERIAL:	<b>CMTDDZ 东莞市田都科技有限公司</b> Dongguan TianDu Technology Co. Ltd.	
LOT NO:		FINISH:		
UNIT: MM	SIZE: A4	COLOR:	TITLE: NANO SIM PUSN 卡座	
TOLERANCES: X. X=±0.35 X. XX=±0.25 X. XXX=±0.15		GENERAL ANGLE: X. X=±3.0° X. XX=±2.0°		DR: ERIC
		CHK:	DWG NO:	REV: A
		APP:	SCALE: 1:1	SHEET: 1 OF 1