

版次(Ed')	变更摘要(Change The Content)	日期(Date)	序号(NO.)	品名(Name)	材质(Material)
1	增加料号说明	2015/1/28	①	0.5后压胶芯(H=2.0) 0.5 PH Backflip Type Housing (H=2.0)	LCP UL94V-0 本色 Natural
2	客诉胶芯两侧断角,加胶改善	2017/11/13	②	0.5后压端子(H=2.0) 0.5 PH Backflip Type Terminal (H=2.0)	铜合金/表面镀金 Copper Alloy/ Gold Plating
3	增加胶芯小缺口,与小PIN结构保持一致	2021/9/19	③	0.5后压后盖(H=2.0) 0.5 PH Backflip Type Actuator (H=2.0)	LCP UL94V-0 黑色 Black
			④	0.5后压焊片(H=2.0) 0.5 PH Backflip Type Fitting Nail (H=2.0)	铜合金/表面镀锡 Copper Alloy/ Tin Plating

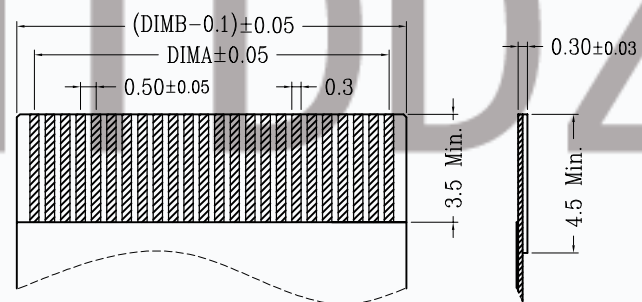
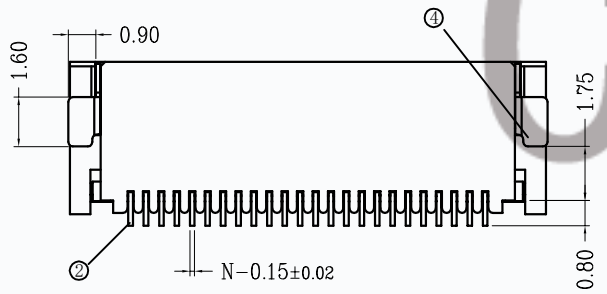
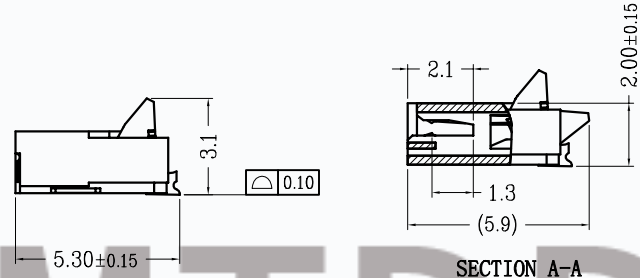
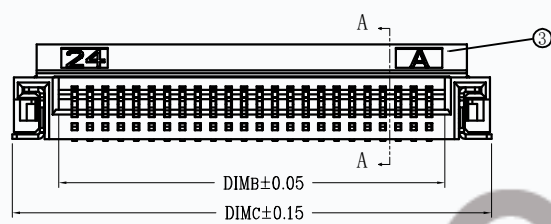
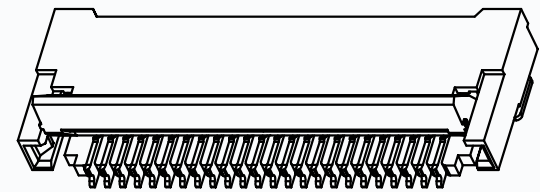
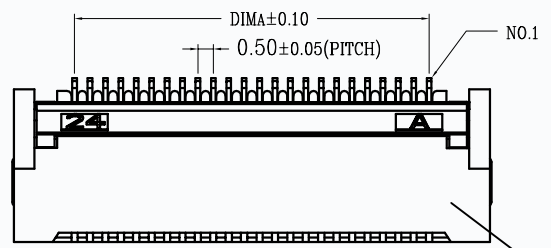

CKT	DIMA	DIMB	DIMC	CKT	DIMA	DIMB	DIMC
4	1.50	2.52	5.54	33	16.00	17.02	20.04
5	2.00	3.02	6.04	34	16.50	17.52	20.54
6	2.50	3.52	6.54	35	17.00	18.02	21.04
7	3.00	4.02	7.04	36	17.50	18.52	21.54
8	3.50	4.52	7.54	37	18.00	19.02	22.04
9	4.00	5.02	8.04	38	18.50	19.52	22.54
10	4.50	5.52	8.54	39	19.00	20.02	23.04
11	5.00	6.02	9.04	40	19.50	20.52	23.54
12	5.50	6.52	9.54	41	20.00	21.02	24.04
13	6.00	7.02	10.04	42	20.50	21.52	24.54
14	6.50	7.52	10.54	43	21.00	22.02	25.04
15	7.00	8.02	11.04	44	21.50	22.52	25.54
16	7.50	8.52	11.54	45	22.00	23.02	26.04
17	8.00	9.02	12.04	46	22.50	23.52	26.54
18	8.50	9.52	12.54	47	23.00	24.02	27.04
19	9.00	10.02	13.04	48	23.50	24.52	27.54
20	9.50	10.52	13.54	49	24.00	25.02	28.04
21	10.00	11.02	14.04	50	24.50	25.52	28.54
22	10.50	11.52	14.54	51	25.00	26.02	29.04
23	11.00	12.02	15.04	52	25.50	26.52	29.54
24	11.50	12.52	15.54	53	26.00	27.02	30.04
25	12.00	13.02	16.04	54	26.50	27.52	30.54
26	12.50	13.52	16.54	55	27.00	28.02	31.04
27	13.00	14.02	17.04	56	27.50	28.52	31.54
28	13.50	14.52	17.54	57	28.00	29.02	32.04
29	14.00	15.02	18.04	58	28.50	29.52	32.54
30	14.50	15.52	18.54	59	29.00	30.02	33.04
31	15.00	16.02	19.04	60	29.50	30.52	33.54
32	15.50	16.52	19.54	80	39.50	40.52	43.54

- 技术指标:
1. 塑件表面应光洁、无毛边、无明显收缩、缺陷、裂纹等现象。(The surface of the plastic parts should be smooth, no rough edges, no obvious shrinkage, defects, cracks and other phenomena.)
  2. 温度范围(Temperature range): -25° C~+85° C.
  3. 额定电压(Rated voltage): 50V, AC/DC(=等效).
  4. 接触电阻(Contact resistance): ≤0.03 Ω.
  5. 绝缘电阻(Insulation resistance): ≥500M Ω
  6. 产品料号(Product material No.):

适用扁平线(Applicable Flat Cable)

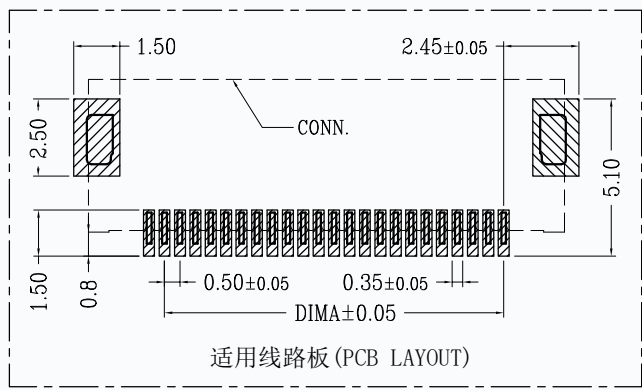

一般公差(TOLERANCE)  
 X ±0.50 .XX ±10  
 X ±0.20 .XXX ±05  
 ANGLES ±1°

T17-0520HY-\*\*\* \*\* \*\* \*\*

NO OF CKT(产品PIN数)

Plating(电镀方式)

Packing(包装方式)

0:端子全雾锡(Terminal all mist tin) T:TUBE管装  
 1:端子全金(G/F OVERALL) R:TAPE & REEL卷装  
 6:端子点镀金(Contact and weld area gold-plated)

00 后盖有LOGO:TD (Actuator with LOGO:TD)  
 OW 后盖无LOGO(Actuator without LOGO)

**CMTDDZ 东莞市田都科技有限公司**  
**Dongguan TianDu Technology Co. Ltd.**

品名(TITLE)	0.5 Pitch后压卧式(H=2.0) 0.5 Pitch H2.0 Backflip R/A Type CONN.	制图(DR)	ERIC
料号(DWG.NO)	T17-0520HY-****-***	校对(CHKD)	
比例(SCALE)	1:1	审核(APPD)	
单位(UNITS)	mm	张数(SHEET)	1 OF 1
		SIZE	A4
		REV	A