

版次 (Ed')	变更摘要 (Change The Content)	日期 (Date)	序号	品名	材质
1	增加料号说明 (Add Material Number Description)	2015/1/28	①	0.5拉拔3代股芯 (H2.0) 0.5 Pitch ZIF Type 3 Housing (H=2.0)	LCP UL94V-0 本色 Natural
			②	0.5拉拔立式3代端子 0.5 Pitch ZIF S/T Type 3 terminal	铜合金/表面镀锡 Copper Alloy/ Tin Plating
			③	0.5拉拔3代后盖 (H2.0) 0.5 Pitch ZIF Type 3 Actuator (H=2.0)	LCP UL94V-0 黑色 Black
			④	0.5拉拔3代焊片 (H2.0) 0.5 Pitch ZIF Type 3 Fitting Nail (H=2.0)	铜合金/表面镀锡 Copper Alloy/ Tin Plating

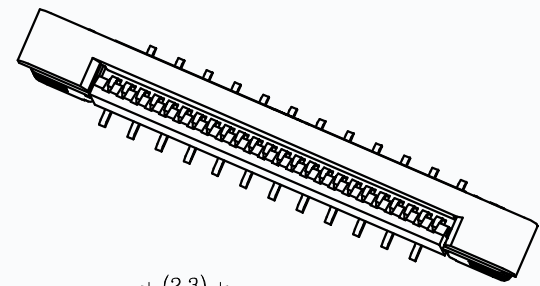

CKT	DIM A	DIM B	DIM C	DIM D	DIM E
35	17.00	18.06	23.10	22.38	
36	17.50	18.56	23.60	22.88	
37	18.00	19.06	24.10	23.38	
38	18.50	19.56	24.60	23.88	
39	19.00	20.06	25.10	24.38	
40	19.50	20.56	25.60	24.88	
41	20.00	21.06	26.10	25.38	
42	20.50	21.56	26.60	25.88	
43	21.00	22.06	27.10	26.38	
44	21.50	22.56	27.60	26.88	
45	22.00	23.06	28.10	27.38	
46	22.50	23.56	28.60	27.88	
47	23.00	24.06	29.10	28.38	
48	23.50	24.56	29.60	28.88	5.00
49	24.00	25.06	30.10	29.38	
50	24.50	25.56	30.60	29.88	
51	25.00	26.06	31.10	30.38	
52	25.50	26.56	31.60	30.88	
53	26.00	27.06	32.10	31.38	
54	26.50	27.56	32.60	31.88	
55	27.00	28.06	33.10	32.38	
56	27.50	28.56	33.60	32.88	
57	28.00	29.06	34.10	33.38	
58	28.50	29.56	34.60	33.88	
59	29.00	30.06	35.10	34.38	
60	29.50	30.56	35.60	34.88	

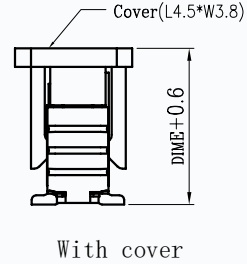
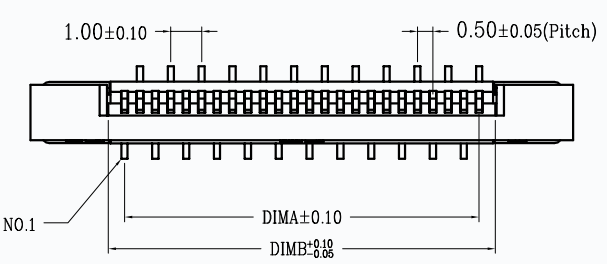
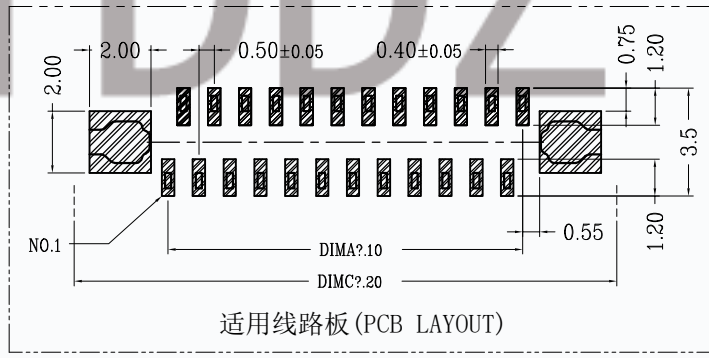
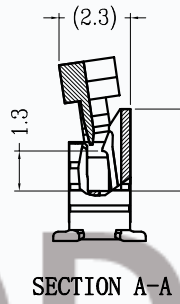
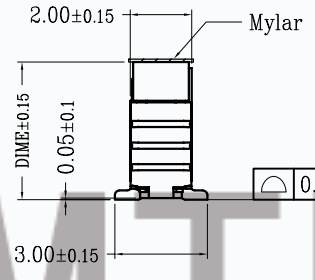
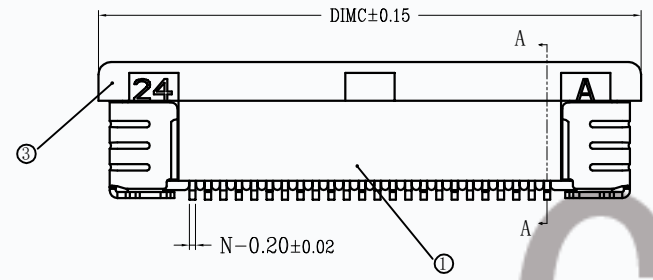

技术指标 (Technical Index):

- 塑件表面应光洁、无毛边、无明显收缩、缺陷、裂纹等现象。
(The surface of the plastic parts should be smooth, no rough edges, no obvious shrinkage, defects, cracks and other phenomena.)
- 温度范围 (Temperature range): -25° C ~ +85° C.
- 额定电压 (Rated voltage): 50V, AC/DC (=等效).
- 接触电阻 (Contact resistance): ≤ 0.03 Ω.
- 绝缘电阻 (Insulation resistance): ≥ 500M Ω.
- 产品料号 (Product material No.):

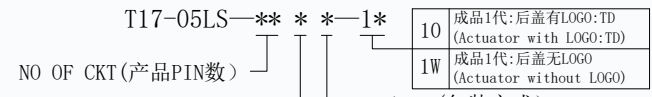

- NO OF CKT (产品PIN数) Packing (包装方式)
- Plating (电镀方式)
- 0: 端子全雾锡 (Terminal all mist tin)
 - 1: 端子全金 (Terminal G/F)
 - OVERALL
- T: TUBE管装
 - R: TAPE & REEL卷装
 - M: TAPE & REEL WITH MYLAR贴MYLAR卷装
 - N: TUBE & WITH MYLAR贴MYLAR管装
 - C: TAPE & REEL WITH COVER加吸盖卷装

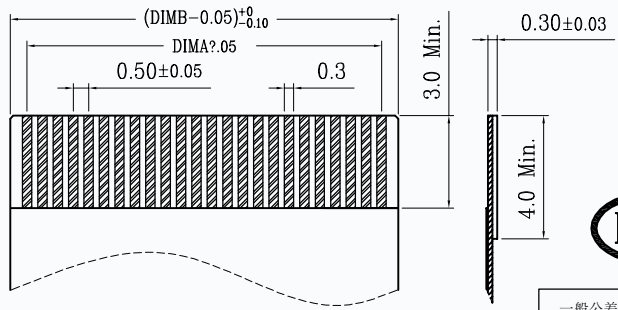

适用扁平线 (Applicable Flat Cable)



一般公差 (TOLERANCE)
X ±.50 .XX ±.10
X ±.20 .XXX ±.05
ANGLES ±1°

CMTDDZ 东莞市田都科技有限公司
Dongguan TianDu Technology Co. Ltd.

品名 (TITLE)	0.5 Pitch 拉拔立式3代正脚位1代 0.5 Pitch H5.5 ZIF S/T Positive Pointer Type CONN.	制图 (DR)	ERIC
料号 (DWG.NO)	T17-05LS-*P-5.0H	校对 (CHKD)	
比例 (SCALE)	1:1	单位 (UNITS)	mm
张数 (SHEET)	2 OF 2	尺寸 (SIZE)	A4
REV	A		