

REV	DESCRIPTION	DATE	APPROVED
AO	初版发行	2019.02.12	ERIC

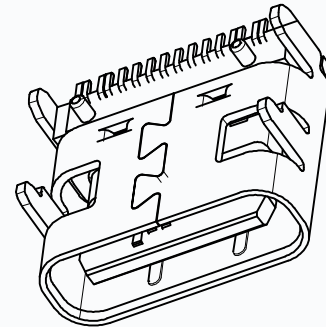

A1	GND	B12	GND
A4	VBUS	B9	VBUS
A5	CC1	B8	SBU2
A6	DP1	B7	DN2
A7	DN1	B6	DP2
A8	SBU1	B5	CC2
A9	VBUS	B4	VBUS
A12	GND	B1	GND
PIN	SIGNAL NAME	PIN	SIGNAL NAME

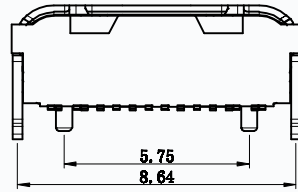
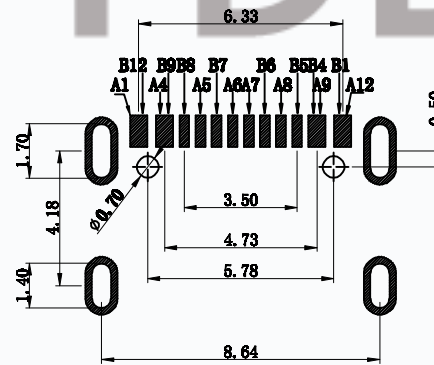
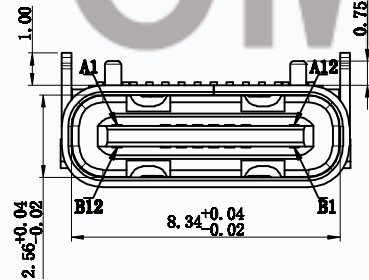
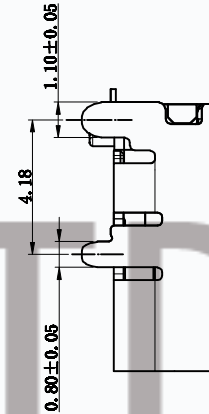
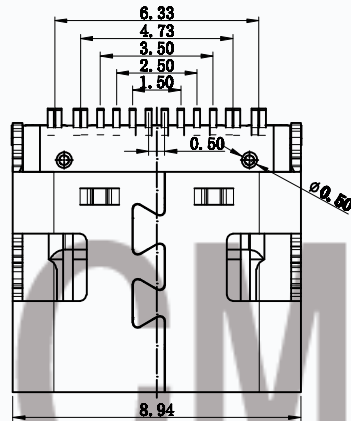
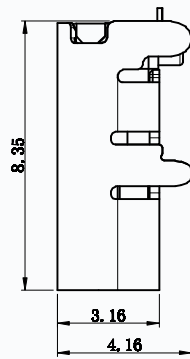

NOTES:

- MECHANICAL: MATING FORCE: 5-20N .  
UNMATING FORCE: 8-20N .  
DURABILITY: 10000 CYCLES MIN.
- ELECTRICAL:  
CURRENT: 5.0A MAX  
VOLTAGE: 20V MAX  
WITHSTANDING VOLTAGE: 100V AC  
CONTACT RESISTANCE: 40 mΩ MAX INITIAL;  
50 mΩ MAX AFTER 10000 CYCLES
- ENVIRONMENTAL:  
OPERATING TEMPERATURE RANGE -30° C ~ +80° C
- Salt Spray: 48H

T11-16BS04-3-L8.35XX X L  
A. WHITE  
B. BLACK  
SEE NOTES 2

BOM			
序号	名称	材料规格	
1	Terminal	C7025 TM02 T=0.15mm	电镀全金 Au:GF Ni:50u"
2	Terminal	C7025 TM02 T=0.15mm	电镀全金 Au:GF Ni:50u"
3	Molding 1	LCP+30%G.F黑色	UL94 V-0
4	Molding 2	LCP+30%G.F黑色	UL94 V-0
5	Molding 3	LCP+30%G.F黑色	UL94 V-0
6	Shell	SUS301 1/2H T=0.30mm	Ni:50u"

TOLERANCE: X ± 0.35 -X ± 0.30 .XX ± 0.25 .XXX ± 0.20	TITLE : TYPE C 16PIN 贴板母座 PART NO. T11-16BS04-3-L8.35-5A DWG NAME.
X ± 5° .X ± 3° .XX ± 1°	

**CMTDDZ** 东莞市田都科技有限公司  
Dongguan TianDu Technology Co. Ltd.

UNITS:	SCALE:	SIZE:	SHEET:	PROJECTION:	REV:	DRAW:	ERIC
MM	1:1	A4	1/2		AO	(设计)	

保密等级: 绝密  保密  普通

符合RoHS 环保要求

变更版次	提出人	工程变更单号	基本描述	时间	修订	审核

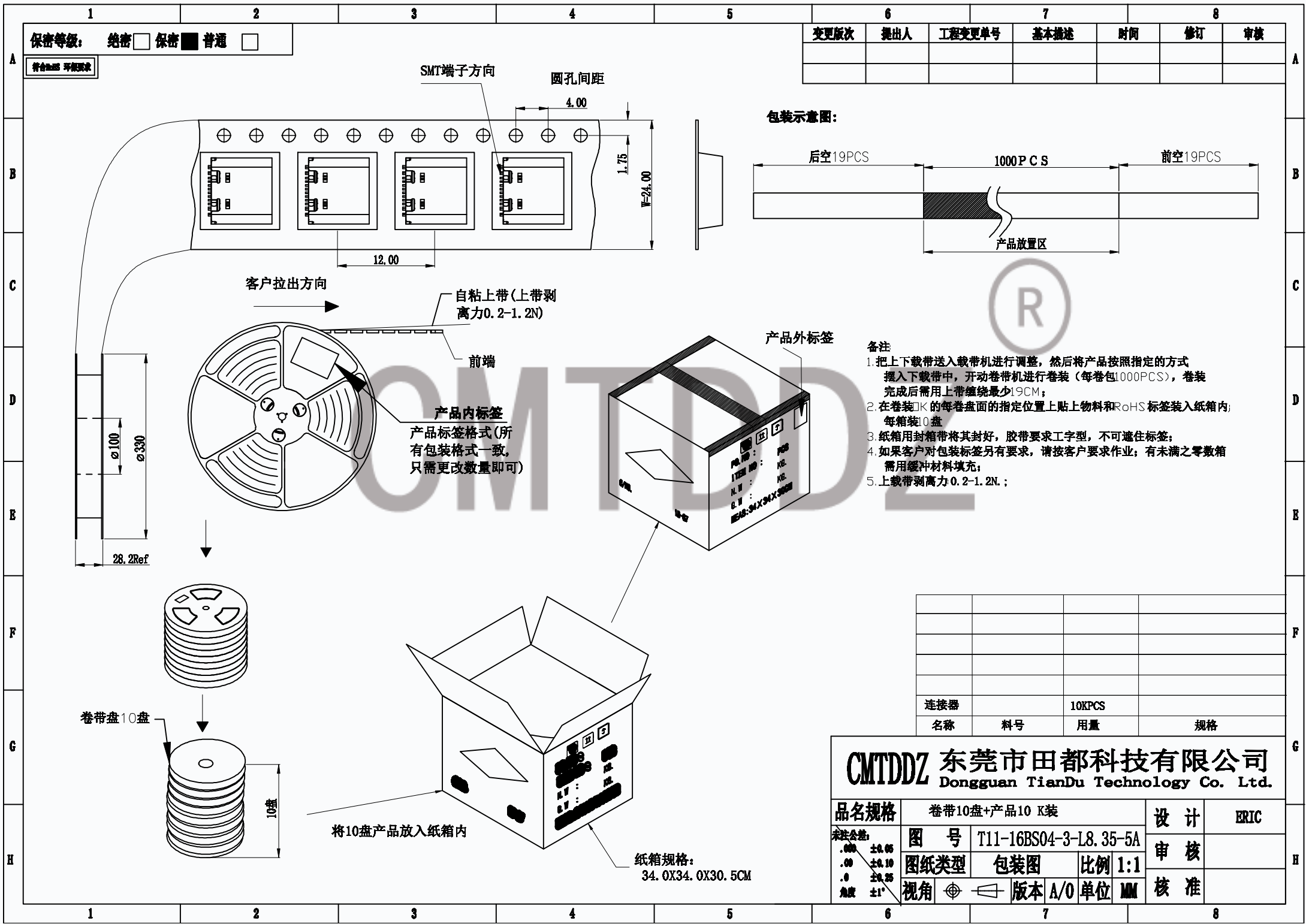

客户拉出方向

SMT端子方向  
圆孔间距

4.00

1.75

F=24.00

12.00

自粘上带(上带剥离力0.2-1.2N)

前端

产品内标签  
产品标签格式(所有包装格式一致,只需更改数量即可)

包装示意图:

后空19PCS

1000 PCS

前空19PCS

产品放置区

产品外标签

备注

- 1.把上下载带送入载带机进行调整,然后将产品按照指定的方式摆入下载带中,开动卷带机进行卷装(每卷包1000PCS),卷装完成后需用上带缠绕最少19CM;
- 2.在卷装OK的每卷盘面的指定位置上贴物料和RoHS标签装入纸箱内;每箱装10盘
- 3.纸箱用封箱带将其封好,胶带要求工字型,不可遮住标签;
- 4.如果客户对包装标签另有要求,请按客户要求作业;有未满足之零数箱需用缓冲材料填充;
- 5.上载带剥离力0.2-1.2N.;

100

330

28.2Ref

卷带盘10盘

10盘

将10盘产品放入纸箱内

纸箱规格:  
34.0X34.0X30.5CM

名称	料号	用量	规格
连接器		10KPCS	

**CMTDDZ 东莞市田都科技有限公司**  
Dongguan TianDu Technology Co. Ltd.

品名规格	卷带10盘+产品10 K装		设计	ERIC
图号	T11-16BS04-3-L8.35-5A	审核		
图纸类型	包装图	比例	1:1	
视角		版本	A/0	单位