

版次	变更摘要	日期
0	新产品发行	2017/2/10

序号	品名	材质
①	1.25- H型卧式WTB胶芯	PA6T UL94V-0 米黄色
②	1.25- H型卧式WTB端子	铜合金/表面镀锡
③	1.25- H型卧式WTB焊片	铜合金/表面镀锡

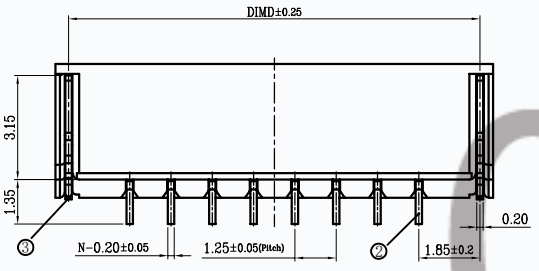
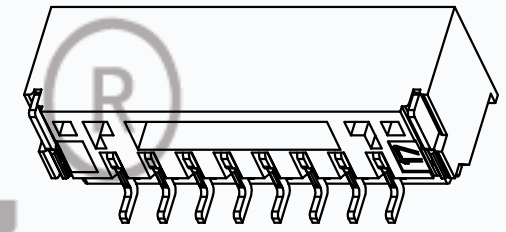
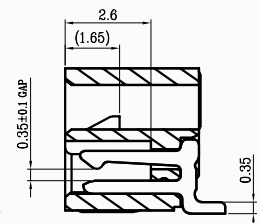
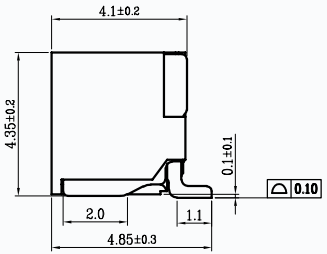
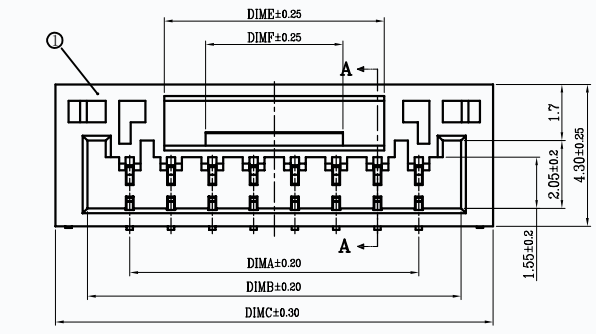

技术指标:

1. 塑件表面应光洁、无毛边、无明显收缩、缺陷、裂纹等现象。
2. 温度范围: -25° C~85° C.
3. 额定电压: 50V AC, DC.
4. 耐电压: 500V AC/minute.
5. 接触电阻: ≤0.02Ω.
6. 绝缘电阻: ≥100MΩ.
7. 额定电流: 1A AC, DC.
8. 产品料号:

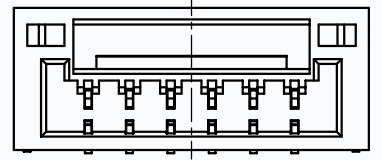

2~6 Pin

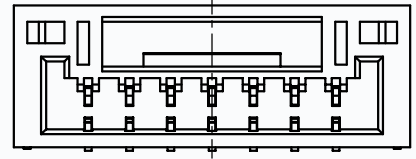

7 Pin

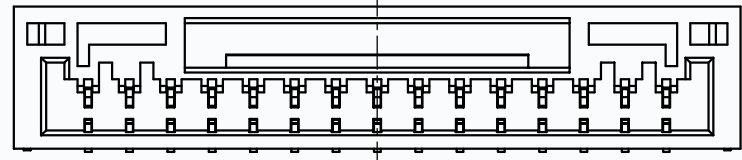

14~18 Pin

T19-125HW-\*\*-\*\* \* \*\* \* \*\*

LO	胶芯材质PA9T本色(白色)无LOGO
OO	胶芯有LOGO:TD
OW	胶芯无LOGO

NO OF CKT (产品PIN数)      Packing (包装方式)

Plating (电镀方式)      T: TUBE 管装

1: 端子全金 (G/F OVERALL)      R: TAPE & REEL 卷装

4: 端子全亮锡

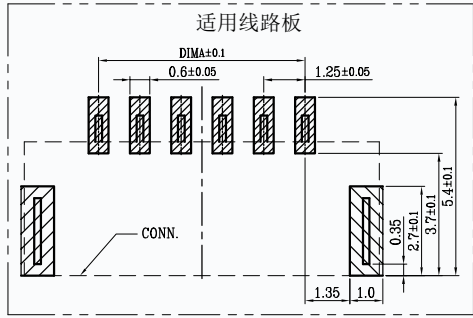

一般公差 (TOLERANCE)  
X ±.50    .XX ±.10  
.X ±.20    .XXX ±.05  
ANGLES    ±1°

CKT	A	B	C	D	E	F
2	1.25	3.80	5.75	4.95	2.15	0.75
3	2.50	5.05	7.00	6.20	3.40	2.00
4	3.75	6.30	8.25	7.45	4.65	3.25
5	5.00	7.55	9.50	8.70	5.90	4.50
6	6.25	8.80	10.75	9.95	7.15	5.75
7	7.50	10.05	12.00	11.20	6.65	4.15
8	8.75	11.30	13.25	12.45	6.65	4.15
9	10.00	12.55	14.50	13.70	7.90	5.40
10	11.25	13.80	15.75	14.95	9.15	6.65
11	12.50	15.05	17.00	16.20	10.40	7.90
12	13.75	16.30	18.25	17.45	11.65	9.15
13	15.00	17.55	19.50	18.70	12.90	10.40
14	16.25	18.80	20.75	19.95	11.65	9.15
15	17.50	20.05	22.00	21.20	11.65	9.15
16	18.75	21.30	23.25	22.45	11.65	9.15
18	21.25	23.80	25.75	24.95	11.65	9.15

**CMTDDZ 东莞市田都科技有限公司**  
Dongguan TianDu Technology Co. Ltd.

品名 (TITLE)	1.25 Pitch H型卧式WTB	制图 (DR)	ERIC
料号 (DWG.NO)	T19-125HW-****-**	校对 (CHKD)	
比例 (SCALE)	1:1	单位 (UNITS)	mm
张数 (SHEET)	1 OF 1	尺寸 (SIZE)	A4
审核 (APPD)		REV	A