

专利授权产品

REV.	ECN	DESCRIPTION	MDF'D	DATE
		新订图面		

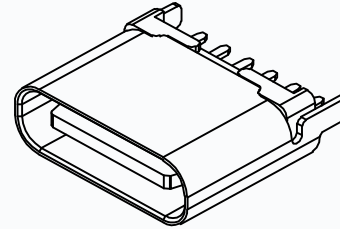
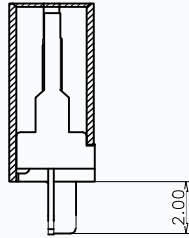
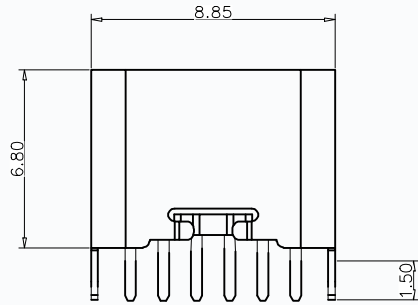

备注 (NOTE):

1 材质:

- 1.1 胶芯: LCP UL94 V-0
- 1.2 端子: C2680, T=0.2mm; 镍底, 镀金
- 1.3 外壳: 不锈钢201-H 表面镀锌

2 电气特性:

- 2.1 接触区: 接触电阻40mΩ Max, 允许10mΩ变化量. 测试条件: 20mv, 100mA下测量.
- 2.2 接触电流: 3A VBUS引脚; 1.25A用于GND引脚; 其他引脚为0.25A.

2.3 额定电压: 5V.

2.4 耐电电压: 100VAC.

2.5 绝缘电阻: 至少100兆欧.

3 机械性能:

- 3.1 插入力: 0.5-2.0Kg
- 3.2 拔出力: 0.6-2.04Kg
- 3.3 插拔次数: 5000次.

4 工作环境: -20℃ to +85℃.

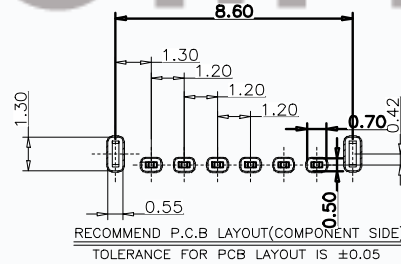
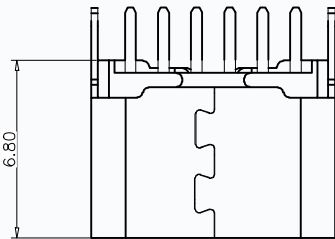
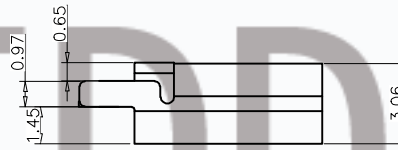
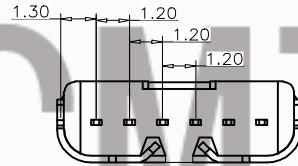
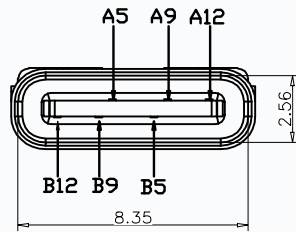

USB TYPE C PIN ASSIGNMENTS

PIN NUMBER	SIGNAL NAME	PIN NUMBER	SIGNAL NAME
		B12	GND
		B9	VBUS
A5	CC1		
		B5	CC2
A9	VBUS		
A12	GND		

TABLE:

NO	PART	Q'TY	Material
1	SHELL	1	ZINC ALLOY, NI30u"Min PLATED
2	CONTACT	6	C2680, TIN80u"/Au1u"/NI30u" PLATED
3	1MD HOUSING	1	LCP UL94 V-0 BLACK
4	CAP	1	LCP UL94 V-0 BLACK
5	WATERPROOF RING	1	SILICONE UL94 V-0 BLACK

CMTDDZ 东莞市田都科技有限公司
Dongguan TianDu Technology Co. Ltd.

页码 (SHEET)	1	单位 (UNIT): MM
版本 (REV)	A1	比例 (SCALE) 1:1
日期 (DATE)	2022. 7. 20	☉ ☐
设计 (DESIGN)	ERIC	未注公差 TOLERANCE UNDEFINIED
审核 (CHECKED)		LI ±0.00
核准 (APPROVED)		LII ±0.15
		LIII ±0.10
		LIV ±0.05
		LV ±0.02

These drawings and specifications are Dongguan TianDu Technology Co. Ltd. The property should not be copied. Without Dongguan TianDu Technology Co. Ltd. Prior written consent to copy or use in any way