

RoHS HF Compliant

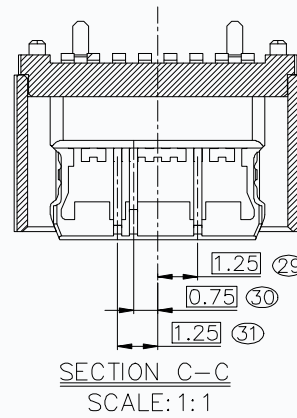

单位 UNIT	mm	◎: Inspection Item	CMTDZ 东莞市田都科技有限公司 Dongguan Tiandu Technology Co., Ltd.
比例 SCALE	1:1	■: Cp/Cpk and SPC Control Item	
数量 SHEET	1/3	TOLERANCE UNLESS OTHERWISE SPECIFIED	图号 DWG NO. T11-08L801-5.5H
制图 DRAWN		.X ±0.25 .X* ±3.0°	名称 TITLE USB 充电单排PIN 圆筒插拔-4.8mm
审核 CHECKED		.XX ±0.15 .X* ±2.0°	角法 PROJ.
批准 APPROVE		.XXX ±0.10 .XX* ±1.0°	

版本 REV.	变更内容 MODIFICATION	日期 DATE	修改 DRAW	批准 APPROVE	核准 APPROVE
------------	----------------------	------------	------------	---------------	---------------

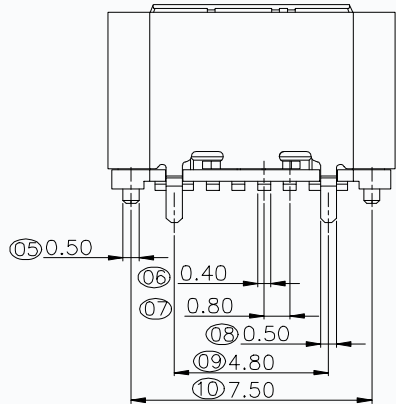
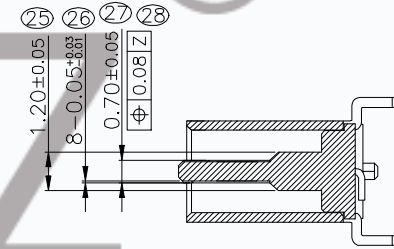
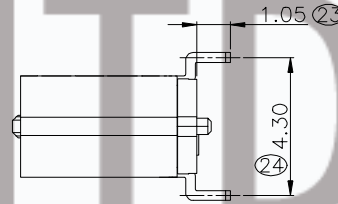
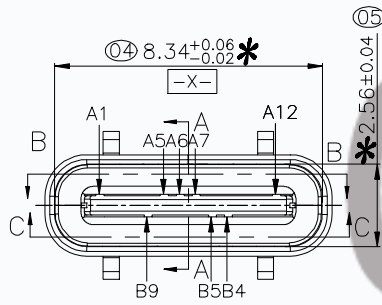
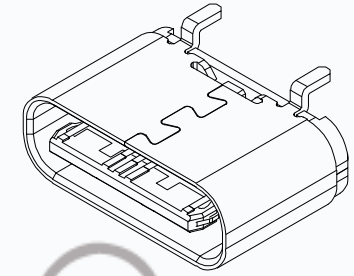
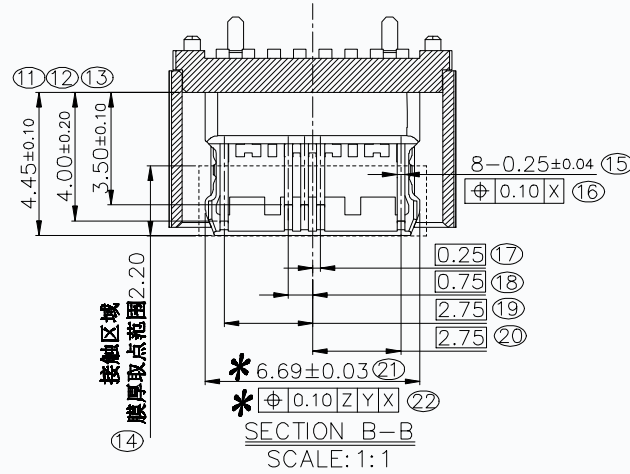
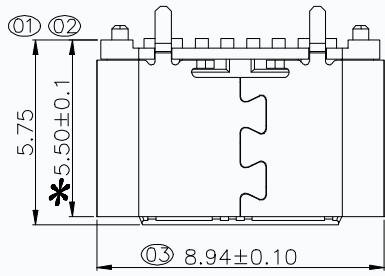
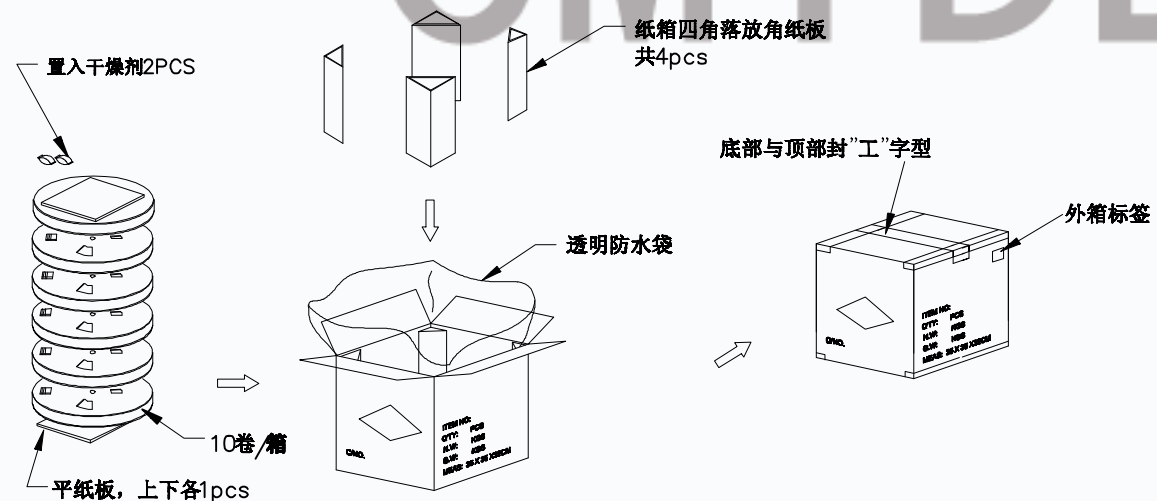
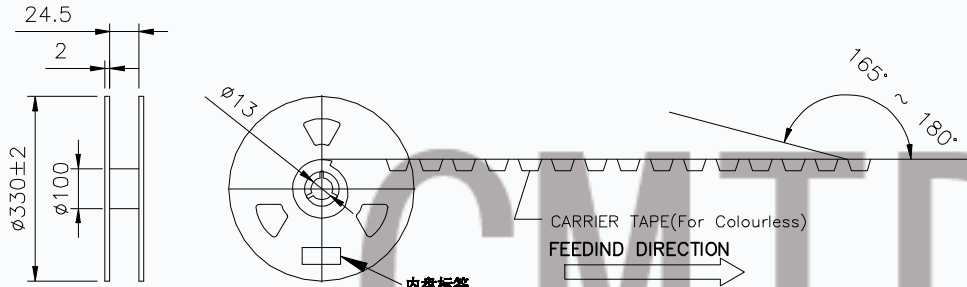
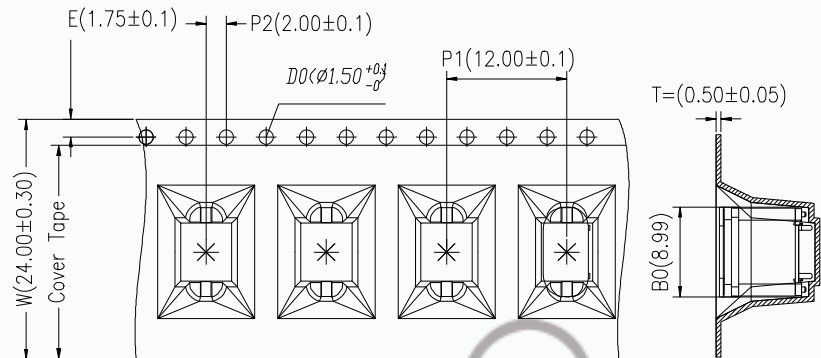
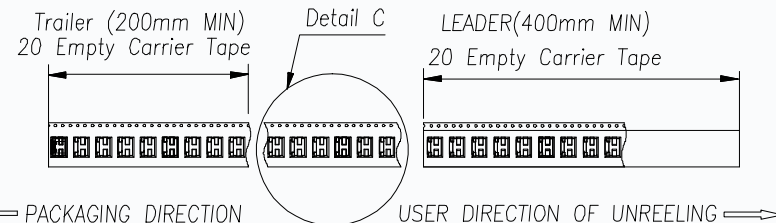

- NOTE:
- MATERIAL;
 - CARRIER TAPE: 0.50T PS, TRANSPARENT
 - COVER TAPE: 0.06T PS
 - SHIPPING CARTON: CORRUGATED FIBER
 - DIMENSION
 - REEL: W=24.5 φ A=330, COLOR: LUCENCY
 - CARRIER TAPE: T=0.50 W=24.0
 - COVER TAPE: T=0.06 W=21.3
 - SHIPPING CARTON:
 - L=350mm W=350mm H=325mm
 - QUANTITY
 - PRIMARY PACKING: 600PCS/REEL
 - SECONDARY PACKING:
 - 10 REELS/CARTON (6000PCS/CARTON)
 - COVER TAPE PEELING FORCE: 20~130 Kgf
 - PEELING SPEED: 300mm/MINUTES
 - PEELING ANGLE: 165°~180°

单位 UNIT	mm	⊗: Inspection Item	CMTDZ 东莞市田都科技有限公司 Dongguan Tiandu Technology Co., Ltd.
比例 SCALE	1:1	■: Cp/Cpk and SPC Control Item	
张数 SHEET	2/3	TOLERANCE UNLESS OTHERWISE SPECIFIED	图号 DWG NO.
制图 DRAWIN		.X ±0.25 X* ±3.0°	T11-08L001-0.0H
审核 CHECKED		.XX ±0.15 .X* ±2.0°	名称 TITLE
版本 REV.		.XXX ±0.10 .XX* ±1.0°	UMS 号由中特研研 国际协议 2-4.2mm
版次 MODIFICATION			角法 PROJ.
日期 DATE			
修改 DRAW			
核准 APPROVE			

版本 REV.	版次 MODIFICATION	日期 DATE	修改 DRAW	核准 APPROVE
------------	--------------------	------------	------------	---------------

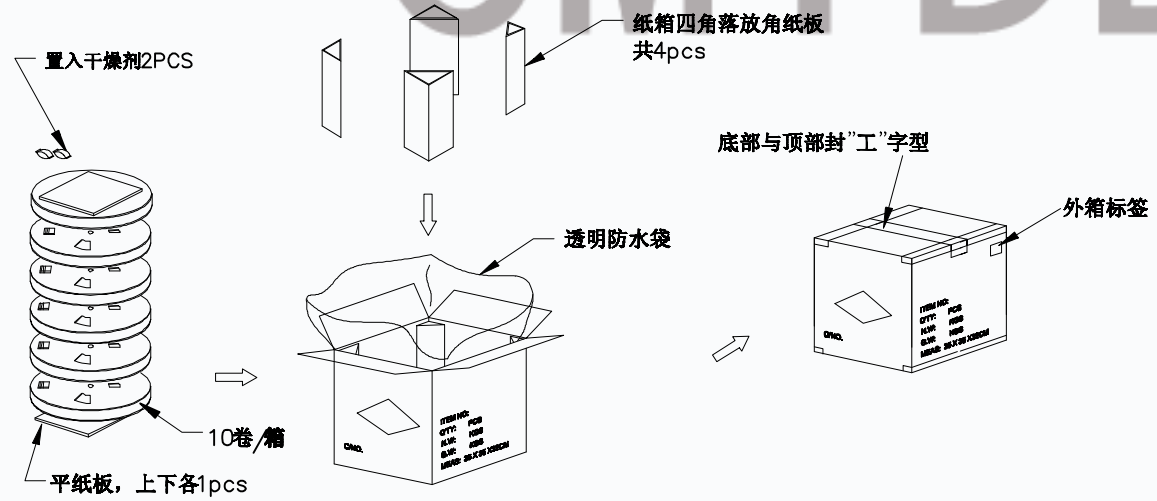
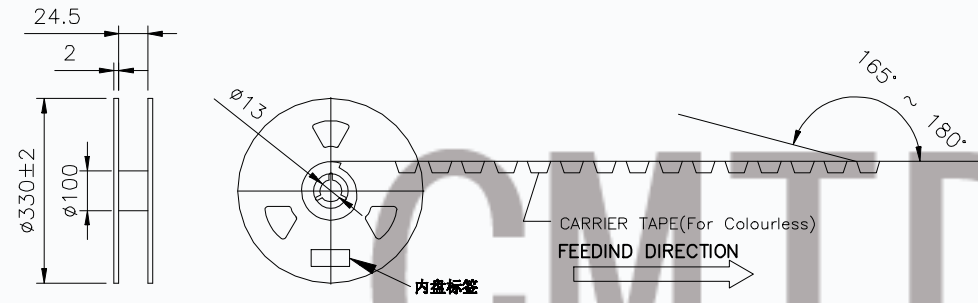
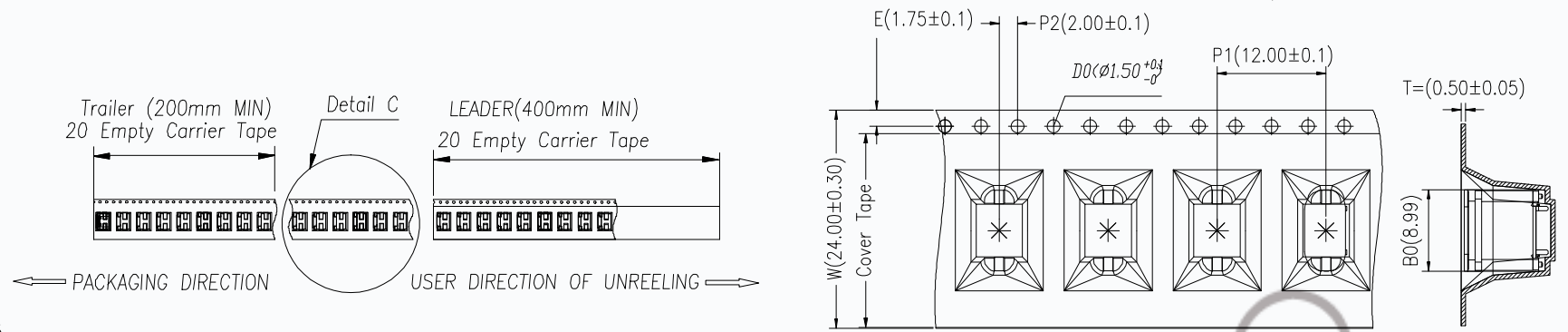

- NOTE:
- MATERIAL;
 - CARRIER TAPE:0.50T PS,TRANSPARENT
 - COVER TAPE:0.06T PS
 - SHIPPING CARTON: CORRUGATED FIBER
 - DIMENSION
 - REEL: W=24.5 ø A=330, COLOR:LUCENCY
 - CARRIER TAPE: T=0.50 W=24.0
 - COVER TAPE: T=0.06 W=21.3
 - SHIPPING CARTON:
 - L=350mm W=350mm H=325mm
 - QUANTITY
 - PRIMAY PACKING:600PCS/REEL
 - SECONARY PACKING:
 - 10 REELS/CARTON(6000PCS/CARTON)
 - COVER TAPE PEELING FORCE:20~130 Kgf
 - PEELING SPEED:300mm/MINUTES
 - PEELING ANGLE:165°~180°

单位 UNIT	mm	◎:Inspection Item	CMTDZ 东莞市田都科技有限公司 Dongguan Hianbu Technology Co., Ltd.
比例 SCALE	1:1	■:Cp/Cpk and SPC Control Item	
数量 SHEET	2/3	TOLERANCE UNLESS OTHERWISE SPECIFIED	图号 DWG. NO.
制图 DRAWIN		.X ±0.25 .X* ±3.0°	番号 TITLE
审核 CHECKED		.XX ±0.15 .X* ±2.0°	角标 PROJ.
		.XXX ±0.10 .XX* ±1.0°	

版本 REV.	版变内容 MODIFICATION	日期 DATE	修改 DRAW	核准 APPROVE	核准 APPROVE
------------	----------------------	------------	------------	---------------	---------------