

CUSTOMER DRAWING

NOTE :
UT03FD014SX01ZA

1. Seletive Plating
 - S1:5u" Gold In Contact Area
100u" Tin In Tail Area
 - S2:0.8u" Gold In Contact Area
100u" Tin In Tail Area
 - S3:10u" Gold In Contact Area
100u" Tin In Tail Area
 - S4:15u" Gold In Contact Area
100u" Tin In Tail Area
 - S5:30u" Gold In Contact Area
100u" Tin In Tail Area

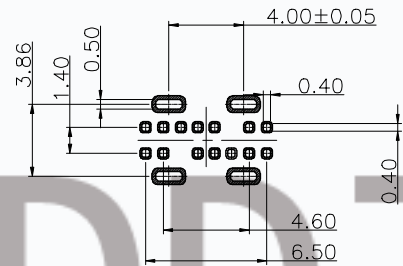
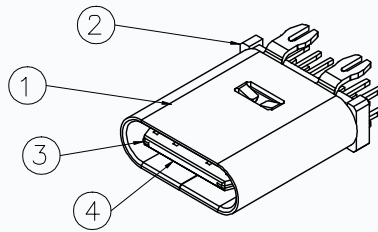
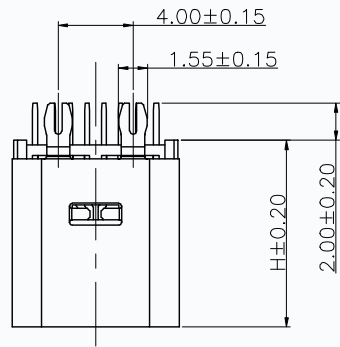

RECOMMENDED P.C.B. LAYOUT
TOLERANCE UNSPECIFIED ±0.05mm

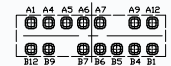
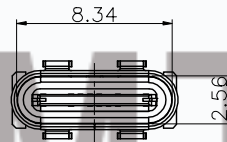
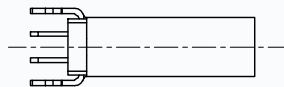

A1	GND	B12	GND
A4	VBUS	B9	VBUS
A5	CC1	B7	DN2
A6	DP1	B6	DP2
A7	DN1	B5	CC2
A8	VBUS	B4	VBUS
A12	GND	B1	GND
PIN	SIGNAL NAME	PIN	SIGNAL NAME

H(mm)
10.0
10.5

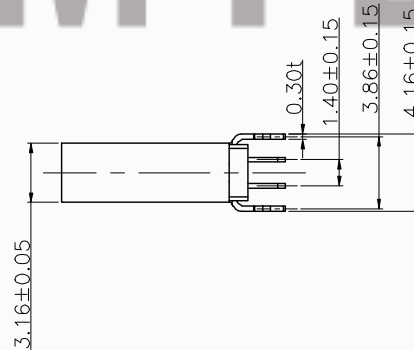
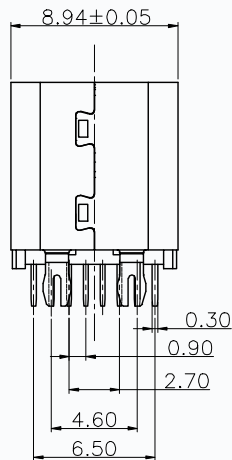

7				
6				
5				
4	TYPE C MD	HIGH TEMP	BLACK	UL 94V-0
3	CENTER PIECE	STAINLESS STEEL	—	NO Plated
2	TYPE C TERMINAL	COPPER ALLOY	—	Gold Plated
1	SHELL	STAINLESS STEEL	—	Ni Plated
NO.	DESCRIPTION	MATERIAL	COLOR	REMARK

CMTDDZ 东莞市田都科技有限公司
Dongguan TianDu Technology Co. Ltd.

							30~	±0.50	DRAW		PART NO.	T11-14LC01-H						
							10~ 30	±0.30	DESIGN		DRAW NAME	TYPE C 2.0#座14PIN 180度插板 (10.0mm/10.5mm)						
							~ 10	±0.15	CHECK		DRAW NO.		REV.	PA				
	PA	NEW	17-08-30	JEFF	ERIC	ANGLES		±2'	APPRO.		UNIT	mm	SCALE	1:1	PAGE	1of1	VIEW	
EGR (DGN) NO.	REV.	DESCRIPTION	DATE	CHANGE	APPRO.	GENERAL TOLERANCE UNLESS OTHERWISE NOTED		APPRO.	UNIT	mm	SCALE	1:1	PAGE	1of1	VIEW			