

REV.	ECN. NO.	APPD.

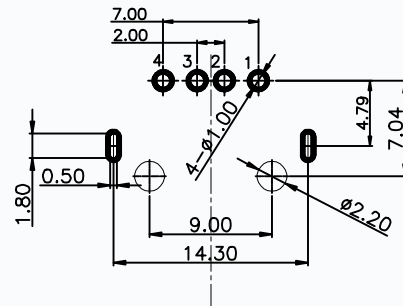
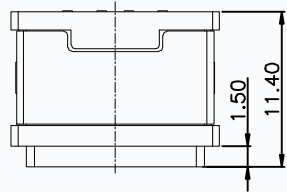

NOTES:
SPECIFICATION:

1. CURRENT RATING: 3.0A MAX
2. DIELECTRIC WITHSTAND VOLTAGE: 100VAC
3. TEMPERATURE RANGE: -30 °C ~ 85 °C
4. CONTACT RESISTANCE: 40 MILLIONHM MAX
5. INSULATION RESISTANCE: 100 MEGOHMS MIN.
6. INSERTION FORCE :10N~30N
7. UNMATING FORCE: 8N~30N
8. DURABILITY:1500 CYCLES

RECOMMENDED PCB LAYOUT(TOP VIEW)

THICKNESS T=1.0mm
DEFAULT TOLERANCE+/-0.05

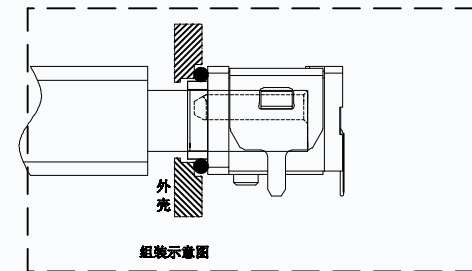
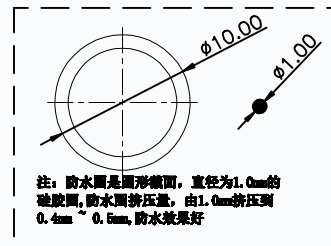
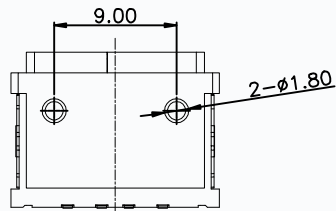
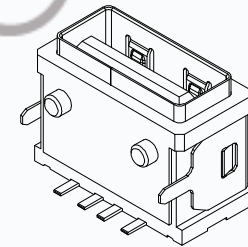
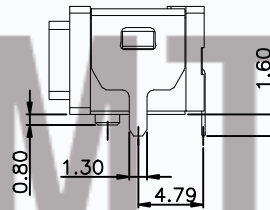
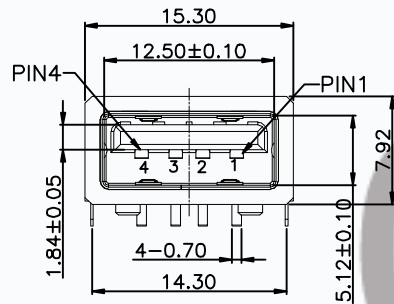

PIN ASSIGNMENT

PIN NO.	1	2	3	4
SIGNAL NAME	VBUS	D-	D+	GND

5	Outer Shell	1	SUS 301 1/4H	
4	Inner Shell	1	SUS 301 1/4H	
3	PLASTIC Shell	1	PA10T (G.F30%)	
2	Contact	4	BRASS C2680-EH Au/Ni Plating T=0.25mm	
1	Housing	1	PA10T (G.F30%)	

ITEM	PART NAME	QTY	FINISH	NOTE
------	-----------	-----	--------	------

X.	± 0.50	X.°	± 2°
.X	± 0.30	.X°	± 1°
.XX	± 0.10	.XX°	± 0.5°
.XXX	± 0.05		

UNITS mm	CMTDDZ 东莞市田都科技有限公司 Dongguan TianDu Technology Co. Ltd.	
MAT'L	PART NO. T10-2F112DF	TITLE: USB 2.0 A TYPE 90度防水
FINISH	APPD: JEFF	DWG NO.: T10-2F112DF
QTY	CHKD: DAVID	
	DR: ERIC	
		SCALE SHEET REV. 1/1 1/1 A1