

RoHS Compliant

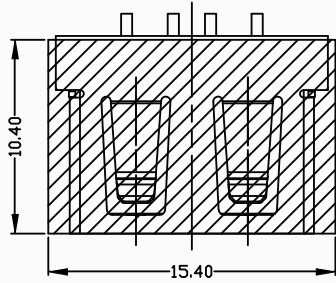

MYLAR 示意图

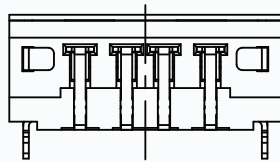
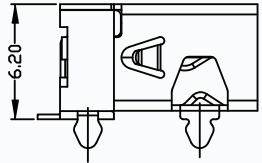

外壳铆合面视图

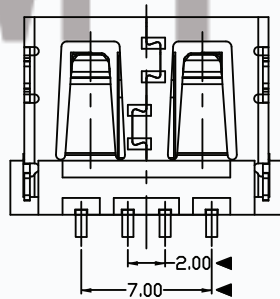
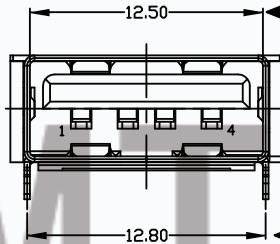
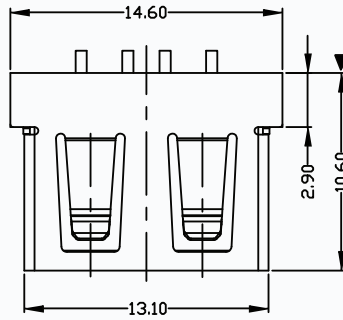

规格说明: Specifications:

电气特性: Electrical:

1. 额定电流: Current Rating  
1.5A/contact terminal
2. 额定电压: Voltage Rating  
30V DC
3. 接触阻抗: Contact Resistance  
30 milliohms MAX
4. 耐电压: Dielectric Withstanding Voltage:  
500 V AC AT Sea Level
5. 绝缘阻抗: Insulation Resistance:  
1000MEGA ohms MIN

物理性能: Mechanical:

1. 插拔力: Connector Mate and Unmate Force  
Mate force: 3.57kgf(MAX)  
Unmate force: 1.02kgf(MIN)
2. 端子保持力: Terminal Retention  
1.0kgf(MIN)
3. 寿命: Durability  
1500 CYCLES MIN

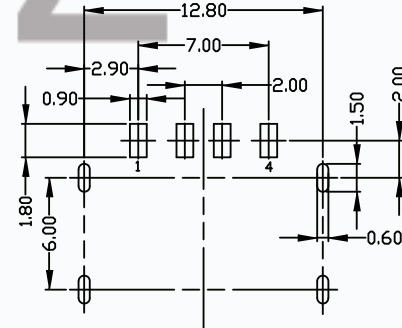

RECOMMENDED PCB LAYOUT

- T10-2F106S-X X X X X X X X
- B=盐雾24H C=盐雾48H
  - 包装方式PACK:  
2: 盘装 3: 管装 4: 载带
  - 端子电镀SPRING PLATING:  
0: 镀金GF 5:5u" 6:15u" 8:30u"
  - 端子材质SPRING CONTACT:  
C: 黄铜 P: 磷铜
  - 外壳电镀SHELL PLATING:  
N: 镀镍 T: 镀雾锡
  - 外壳材质SHELL:  
S: 不锈钢 C: 黄铜 A: 冷轧钢板
  - 塑胶颜色HOUSING COLOUR:  
W: 白色 B: 黑色 L: 蓝色 Y: 黄色 G: 绿色
  - 塑胶材质HOUSING:  
0: PBT 3: LCP 6: PA-6T 9: PA-9T

<b>CMTDDZ</b> 东莞市田都科技有限公司 Dongguan Tiandu Technology Co., Ltd TEL: 0769-85384807 FAX: 0769-85384842		图号 (DWG NO)	单位 (UNIT): MM
		版本 (REV)	A/0
品名 (ITEM NO)		日期 (DATE)	比例 (SCALE) 1:1
料号 (PART NO)		2015.06.09	未注公差 TOLERANCE UNSPECIFIED
模号 (MODEL NO)		ERIC	I X ±0.30 I XX ±0.20 I XXX ±0.10 I <sup>+</sup> ±0.5 <sup>+</sup> I <sup>+</sup> ±0.2 <sup>+</sup>
USB A/F短体10.6直边贴片4脚圆脚 6.2H		设计 (DESIGN)	~
T10-2F106S-XXXXXXX		审核 (CHECKED)	
N/A		核准 (APPROVED)	