

CAD FILE:

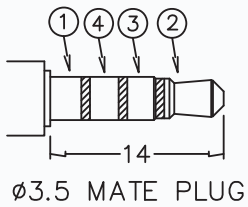
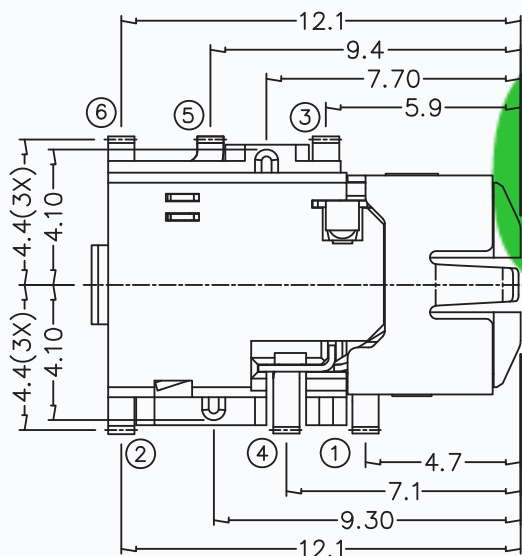
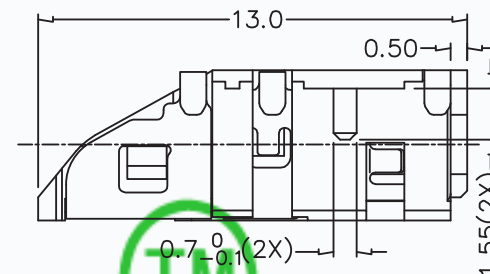
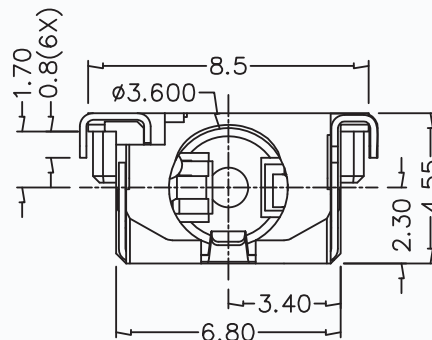
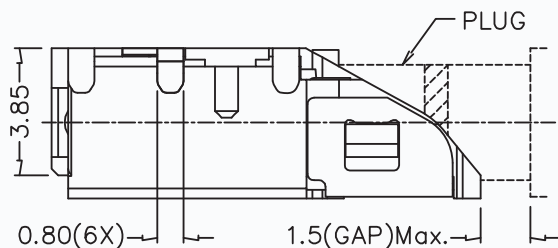
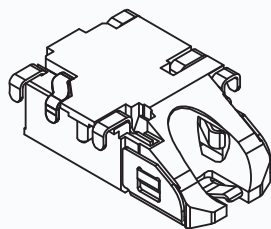

CMTDDZ

* MATERIAL

- TERMINAL 1 : COPPER ALLOY
- TERMINAL 2 : COPPER ALLOY
- TERMINAL 3 : COPPER ALLOY
- TERMINAL 4 : COPPER ALLOY
- TERMINAL 5 : COPPER ALLOY
- TERMINAL 6 : COPPER ALLOY
- HOUSING : PA10T
- INSULATOR : PA10T

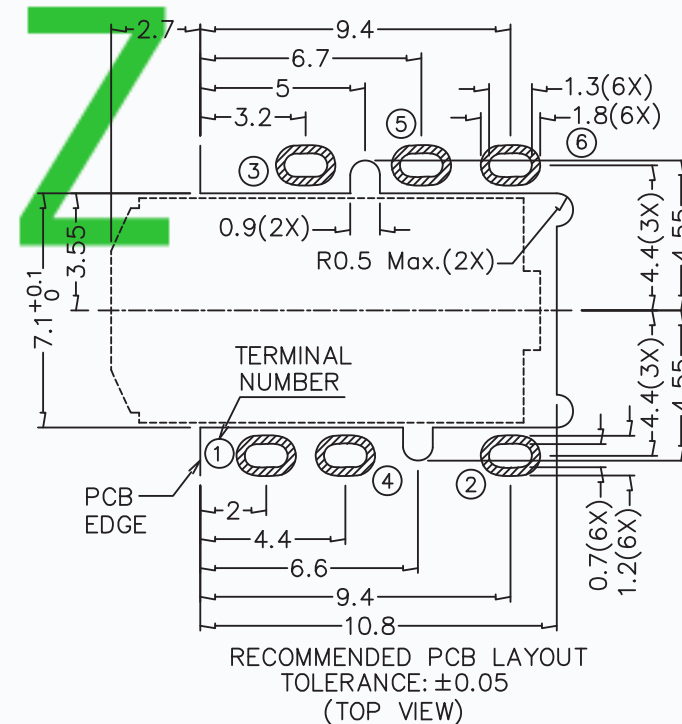
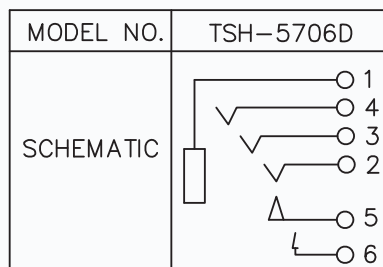

APPD.	DESCRIPTIONS OF REVISION

TOLERANCE UNLESS SPECIFIED
WITHIN 1.5mm : ±0.1mm
OVER 1.5mm : ±0.2mm

THESE DRAWINGS AND SPECIFICATIONS ARE THE PROPERTY OF DONGGUAN TIANDU ELECTRONICS CO.,LTD. AND SHALL NOT BE REPRODUCED, COPIED OR USED IN ANY MANNER WITHOUT THE PRIOR WRITTEN CONSENT OF DONGGUAN TIANDU ELECTRONICS CO., LTD.

TITLE : 3.5mm PHONE JACK	UNIT : mm	DRWG NO.: CMTDDZ-T13-3570-00
MODEL: T13-3570D	SCALE: 3:1	DWN. ERIC
CMTDDZ 东莞市田都电子有限公司	DONGGUAN TIANDU ELECTRONICS CO.,LTD.	CHK'D MAIKO
		APPD. Coco
