

CAD FILE:

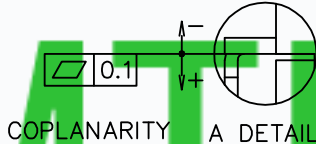

* MATERIAL

- TERMINAL 1 : COPPER ALLOY
- TERMINAL 2 : COPPER ALLOY
- TERMINAL 3 : COPPER ALLOY
- TERMINAL 4 : COPPER ALLOY
- TERMINAL 10 : BRASS
- TERMINAL 11 : BRASS
- TERMINAL 12 : BRASS
- HOUSING : PA6T

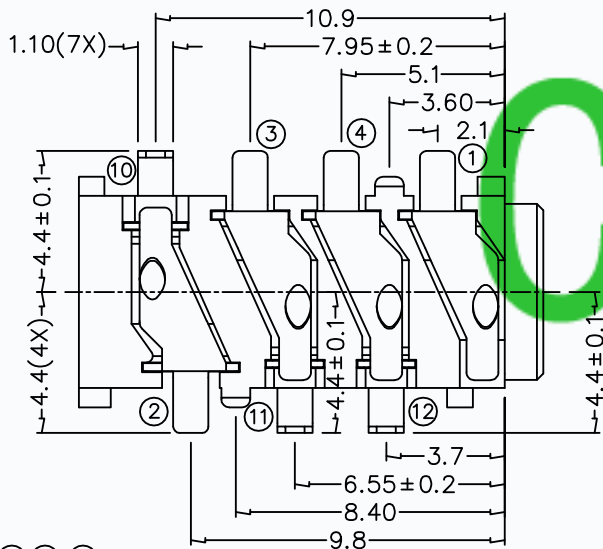
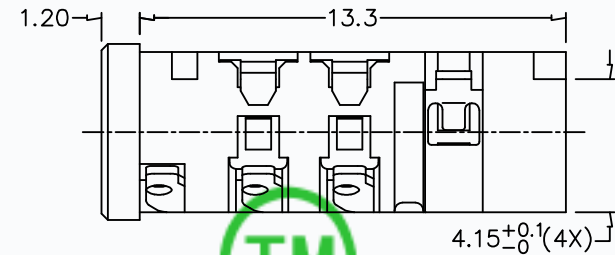
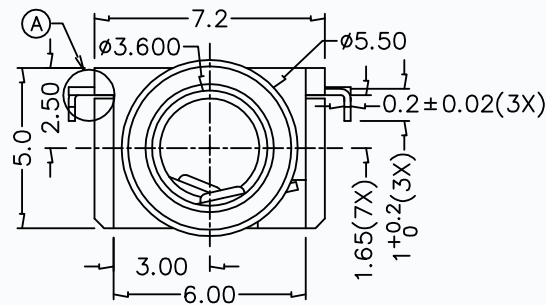
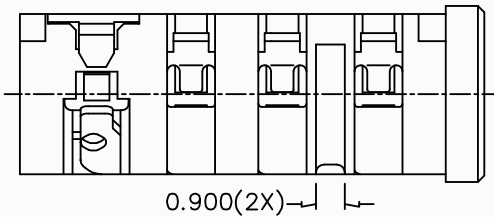
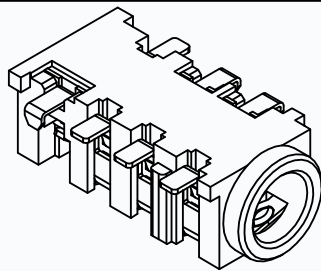
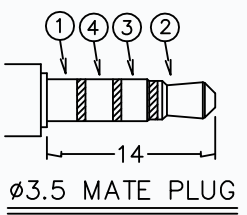
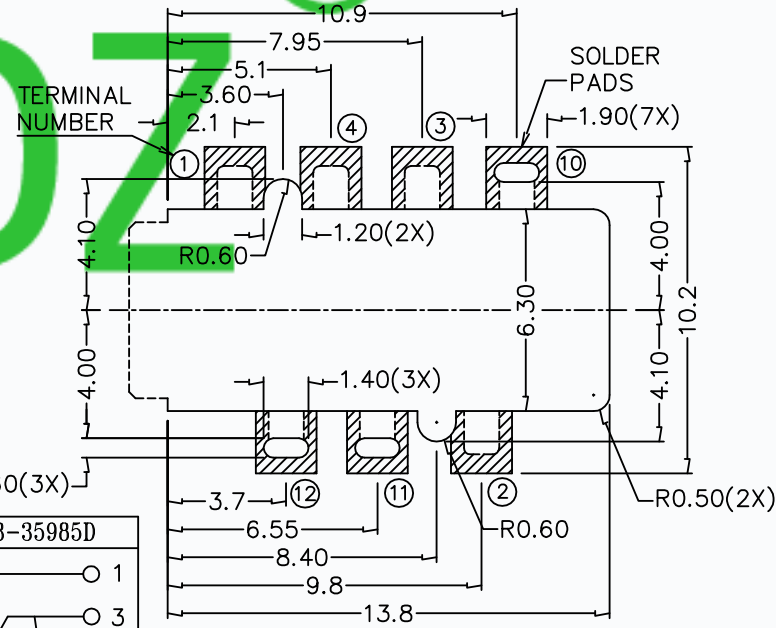

MODEL NO.	T13-35987D	T13-35986AD	T13-35985AD	T13-35984D	T13-35985D
SCHMATIC					

APPD.	DESCRIPTIONS OF REVISION

**TOLERANCE
UNLESS SPECIFIED**
 WITHIN 1.5mm : ±0.1mm
 OVER 1.5mm : ±0.2mm

THESE DRAWINGS AND SPECIFICATIONS ARE THE PROPERTY OF DONGGUAN TIANDU ELECTRONICS CO.,LTD. AND SHALL NOT BE REPRODUCED, COPIED OR USED IN ANY MANNER WITHOUT THE PRIOR WRITTEN CONSENT OF DONGGUAN TIANDU ELECTRONICS CO., LTD.

TITLE : 3.5mm SMD PHONE JACK
MODEL: T13-3598D
CMTDDZ 东莞市田都电子有限公司
 DONGGUAN TIANDU ELECTRONICS CO.,LTD.

UNIT : mm	DRWG NO.: CMTDDZ-T13-3598D-00
SCALE: 3:1	DWN. ERIC 2013-6-17
APPD. Coco	CHK'D MAIKO 2013-6-17
	APPD. Coco 2013-6-17