

CAD FILE:

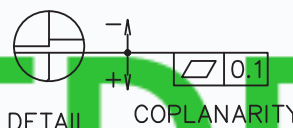

* MATERIAL

- TERMINAL 1 : COPPER ALLOY
- TERMINAL 2 : COPPER ALLOY
- TERMINAL 3 : COPPER ALLOY
- TERMINAL 4 : COPPER ALLOY
- TERMINAL 10: COPPER ALLOY
- TERMINAL 11: COPPER ALLOY
- TERMINAL 12: COPPER ALLOY
- HOUSING : PA6T

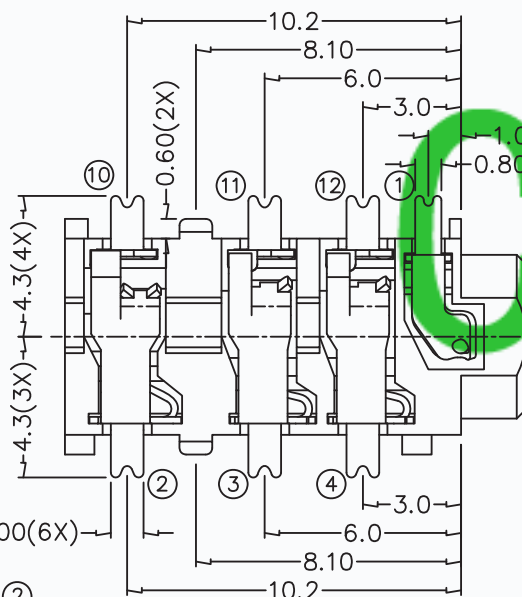
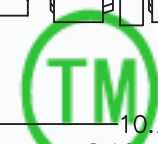
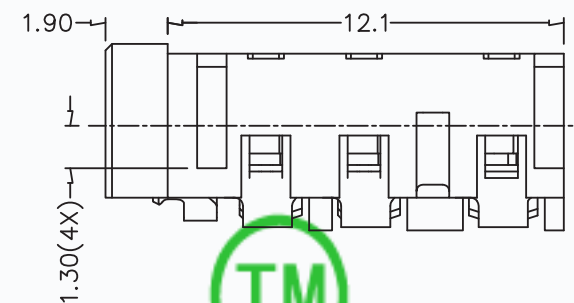
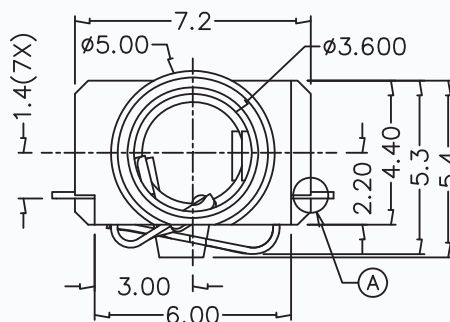
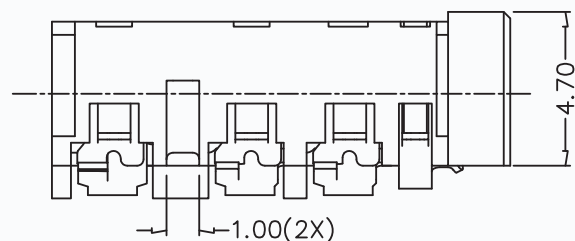
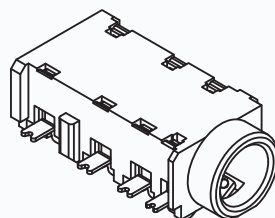
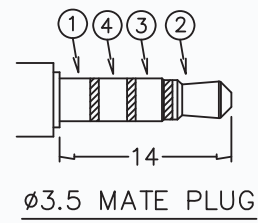
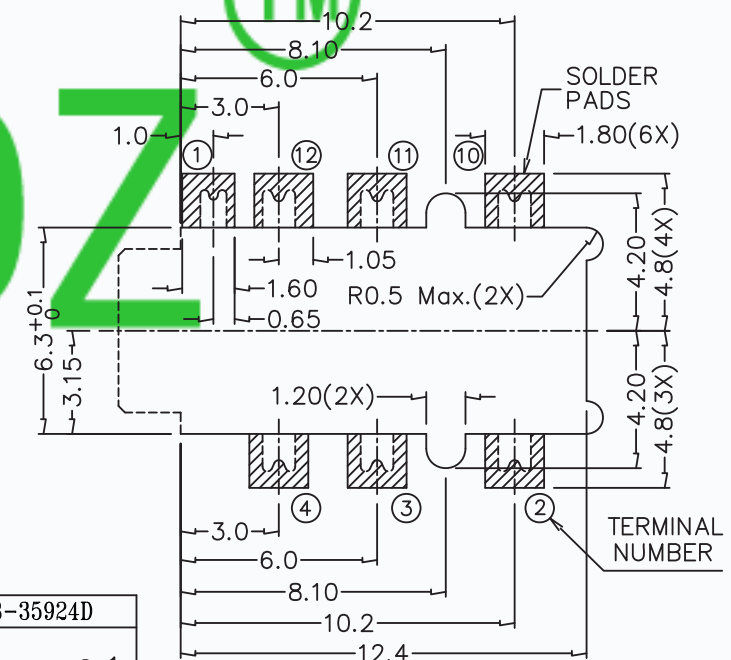

MODEL NO.	T13-35927D	T13-35926AD	T13-35925AD	T13-35925BD	T13-35924D
SCHMATIC					

APPD.	DESCRIPTIONS OF REVISION

TOLERANCE
UNLESS SPECIFIED

WITHIN 1.5mm : ±0.1mm
OVER 1.5mm : ±0.2mm

THESE DRAWINGS AND SPECIFICATIONS ARE THE PROPERTY OF DONGGUAN TIANDU ELECTRONICS CO.,LTD. AND SHALL NOT BE REPRODUCED, COPIED OR USED IN ANY MANNER WITHOUT THE PRIOR WRITTEN CONSENT OF DONGGUAN TIANDU ELECTRONICS CO., LTD.

TITLE : 3.5mm SMD PHONE JACK

MODEL: T13-3592D

CMTDDZ 东莞市田都电子有限公司
DONGGUAN TIANDU ELECTRONICS CO.,LTD.

UNIT : mm	DRWG NO.: CMTDDZ-T13-3592D-00
SCALE: 3:1	DWN. ERIC 2013-6-17
APPD. Coco	CHK'D MAIKO 2013-6-17
	2013-6-17