

CAD FILE:

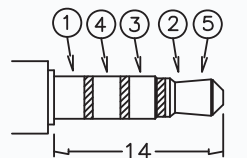
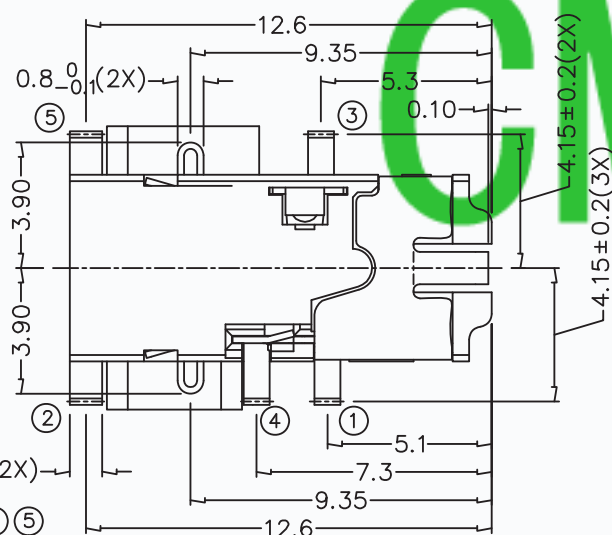
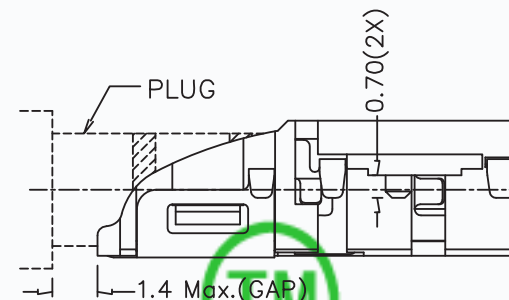
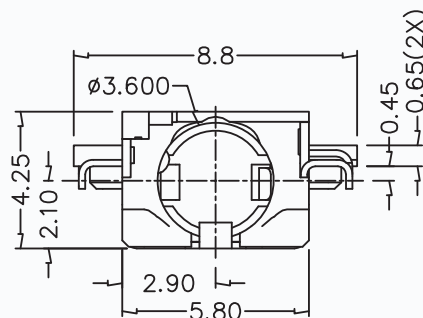
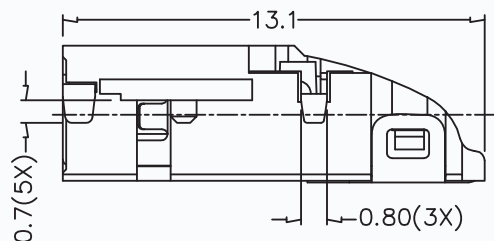
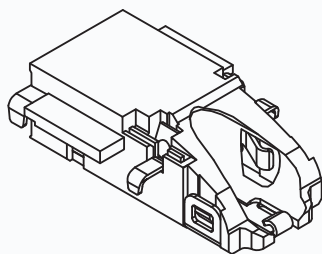

ø3.5 MATE PLUG

* MATERIAL

- TERMINAL 1 : COPPER ALLOY
- TERMINAL 2 : COPPER ALLOY
- TERMINAL 3 : COPPER ALLOY
- TERMINAL 4 : COPPER ALLOY
- TERMINAL 5 : COPPER ALLOY
- HOUSING : PA10T

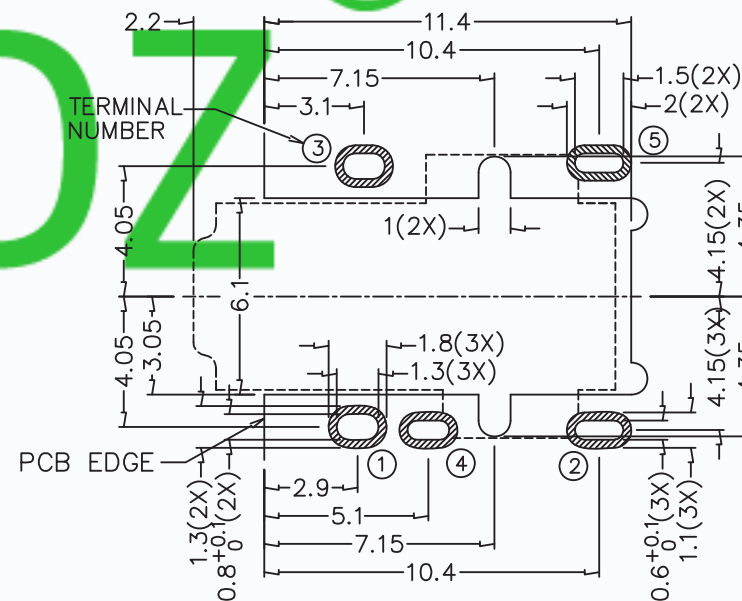
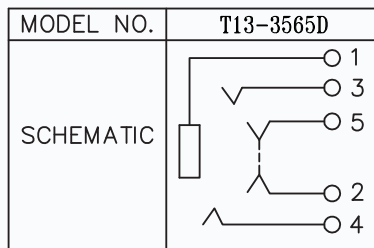

RECOMMENDED PCB LAYOUT
TOLERANCE: ±0.05
(TOP VIEW)

TOLERANCE
UNLESS SPECIFIED
WITHIN 1.5mm : ±0.1mm
OVER 1.5mm : ±0.2mm

THESE DRAWINGS AND SPECIFICATIONS
ARE THE PROPERTY OF DONGGUAN
TIANDU ELECTRONICS CO.,LTD. AND
SHALL NOT BE REPRODUCED. COPIED
OR USED IN ANY MANNER WITHOUT
THE PRIOR WRITTEN CONSENT OF
DONGGUAN TIANDU ELECTRONICS CO., LTD.

TITLE : 3.5mm PHONE JACK

UNIT : mm

DRWG NO.: CMTDDZ-T13-3565-00

MODEL: T13-3565D

SCALE: 3:1

DWN.	ERIC	2013-6-17
------	------	-----------

CMTDDZ 东莞市田都电子有限公司
DONGGUAN TIANDU ELECTRONICS CO.,LTD.

CHK'D	MAIKO	2013-6-17
APPD.	Coco	2013-6-17

APPD.	DESCRIPTIONS OF REVISION
-------	--------------------------