

CAD FILE:

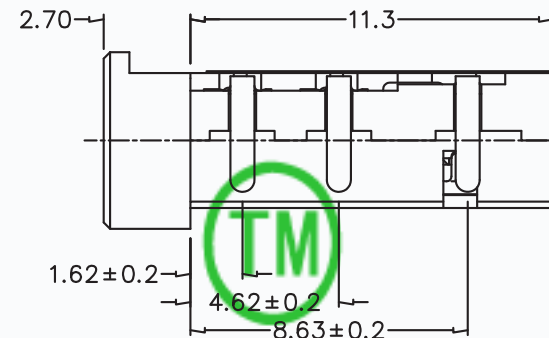
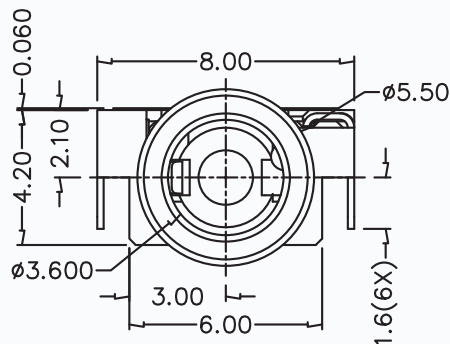
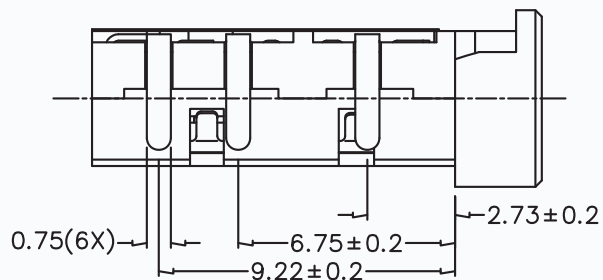
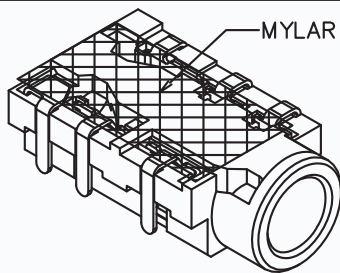

CMTDDZ

*** MATERIAL**

- TERMINAL 1 : COPPER ALLOY
- TERMINAL 2 : COPPER ALLOY
- TERMINAL 3 : COPPER ALLOY
- TERMINAL 4 : COPPER ALLOY
- TERMINAL 5 : COPPER ALLOY
- TERMINAL 10 : COPPER ALLOY
- MYLAR : POLYIMIDE
- HOUSING : PA10T

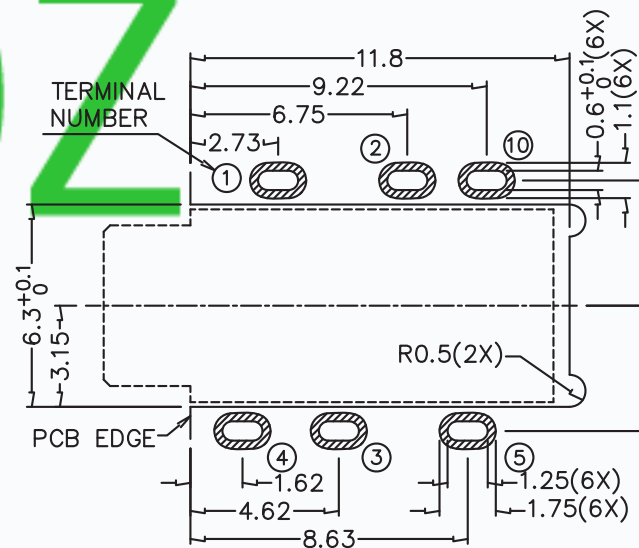
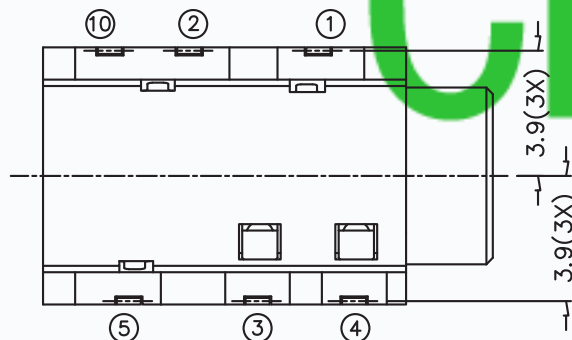

RECOMMENDED PCB LAYOUT
TOLERANCE: ±0.05
(TOP VIEW)

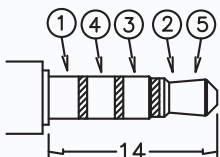

φ3.5 MATE PLUG

MODEL NO.	T13-3568D
SCHMATIC	

APPD.	DESCRIPTIONS OF REVISION
-------	--------------------------

TOLERANCE UNLESS SPECIFIED
WITHIN 1.5mm : ±0.1mm
OVER 1.5mm : ±0.2mm

THESE DRAWINGS AND SPECIFICATIONS ARE THE PROPERTY OF DONGGUAN TIANDU ELECTRONICS CO.,LTD. AND SHALL NOT BE REPRODUCED. COPIED OR USED IN ANY MANNER WITHOUT THE PRIOR WRITTEN CONSENT OF DONGGUAN TIANDU ELECTRONICS CO., LTD.

TITLE : 3.5mm PHONE JACK
MODEL: T13-3568D
CMTDDZ 东莞市田都电子有限公司 DONGGUAN TIANDU ELECTRONICS CO.,LTD.

UNIT : mm	DRWG NO.: CMTDDZ-T13-3568-00
SCALE: 3:1	DWN. ERIC 2013-6-17
APPD. Coco	CHK'D MAIKO 2013-6-17
	APPD. Coco 2013-6-17