

CAD FILE:

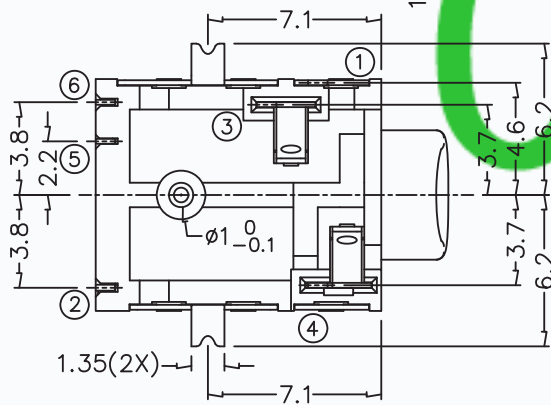
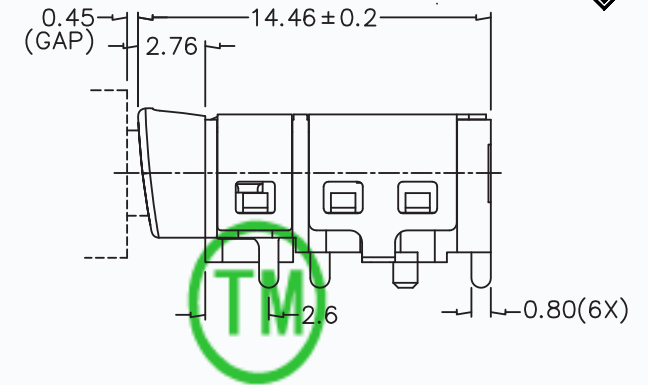
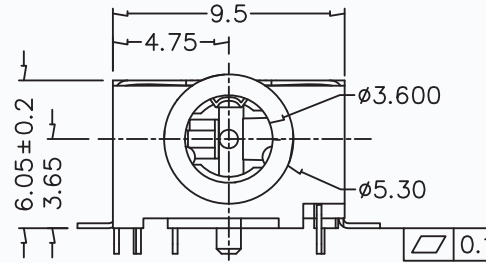
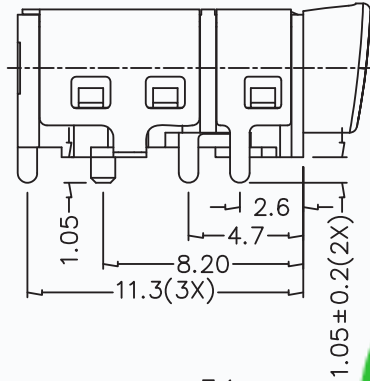
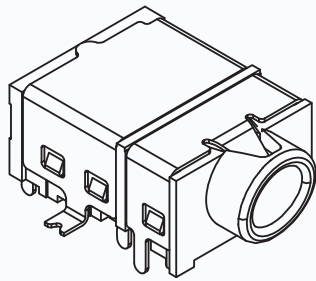
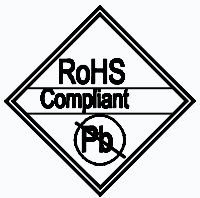

*** MATERIAL**

- TERMINAL 1 : COPPER ALLOY
- TERMINAL 2 : COPPER ALLOY
- TERMINAL 3 : COPPER ALLOY
- TERMINAL 4 : COPPER ALLOY
- TERMINAL 5 : COPPER ALLOY
- TERMINAL 6 : COPPER ALLOY
- SHIELD : BRASS
- HOUSING : PA10T
- INSULATOR : PA10T

CMTDDZ

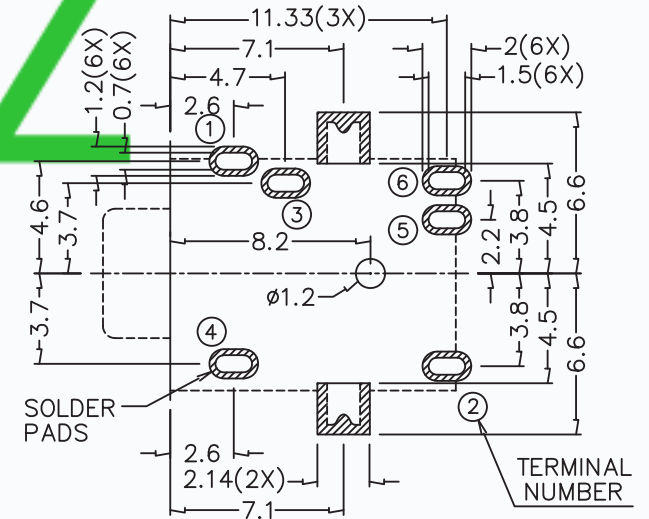
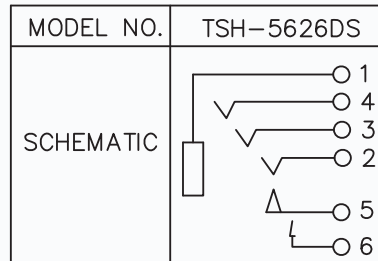

RECOMMENDED PCB LAYOUT
TOLERANCE: ±0.05
(TOP VIEW)

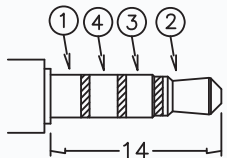

Ø3.5 MATE PLUG

APPD.	DESCRIPTIONS OF REVISION	TOLERANCE UNLESS SPECIFIED WITHIN 1.5mm : ±0.1mm OVER 1.5mm : ±0.2mm	THESE DRAWINGS AND SPECIFICATIONS ARE THE PROPERTY OF DONGGUAN TIANDU ELECTRONICS CO.,LTD. AND SHALL NOT BE REPRODUCED. COPIED OR USED IN ANY MANNER WITHOUT THE PRIOR WRITTEN CONSENT OF DONGGUAN TIANDU ELECTRONICS CO., LTD	TITLE : 3.5mm PHONE JACK	UNIT : mm	DRWG NO.: CMTDDZ-T13-3562-00		
				MODEL: T13-3562D	SCALE: 3:1	DWN.	ERIC	2013-6-17
				CMTDDZ 东莞市田都电子有限公司 DONGGUAN TIANDU ELECTRONICS CO.,LTD.	APPD.	Coco	2013-6-17	