

CAD FILE:

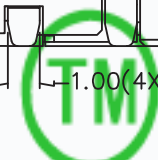

# CMTDDZ

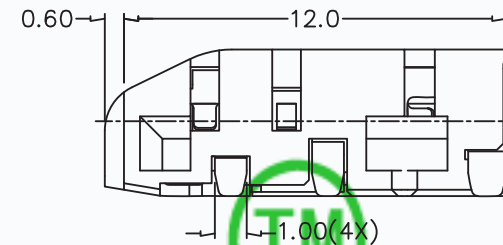
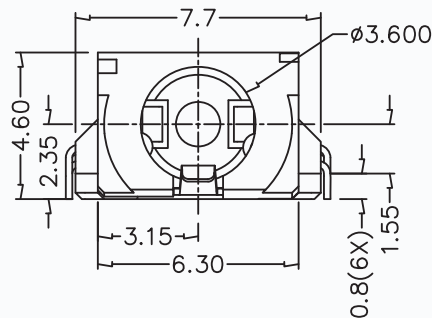
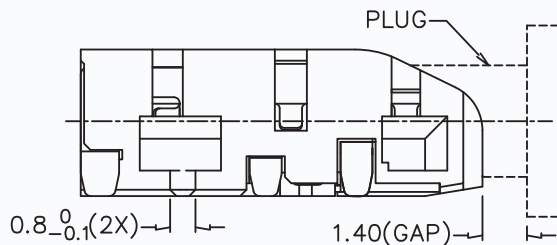
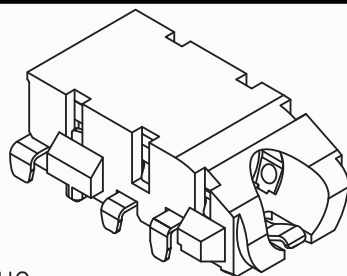
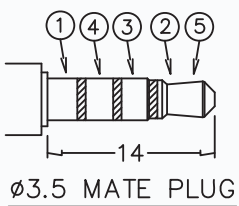
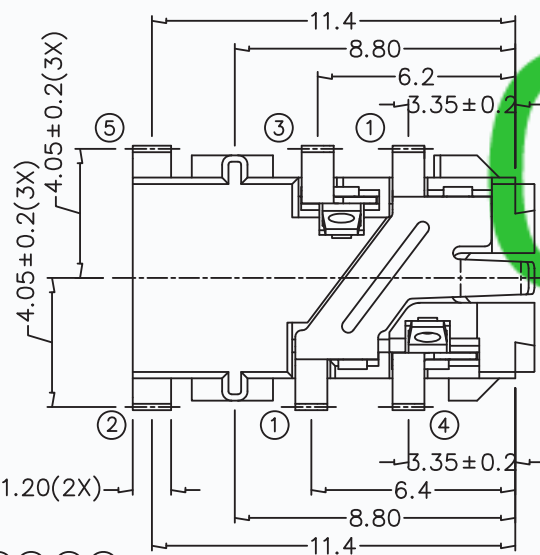

### \* MATERIAL

- TERMINAL 1 : COPPER ALLOY
- TERMINAL 2 : COPPER ALLOY
- TERMINAL 3 : COPPER ALLOY
- TERMINAL 4 : COPPER ALLOY
- TERMINAL 5 : COPPER ALLOY
- HOUSING : PA6T

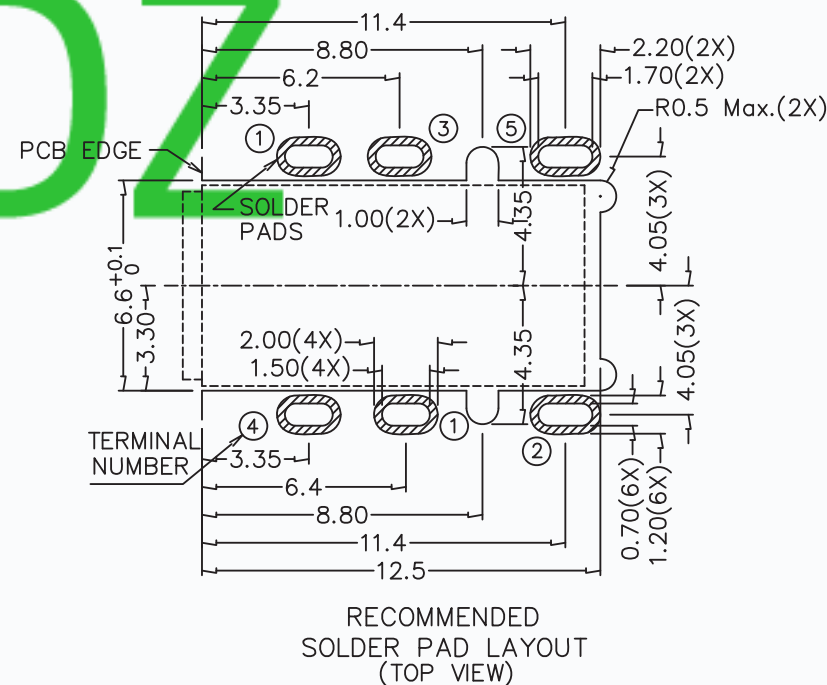
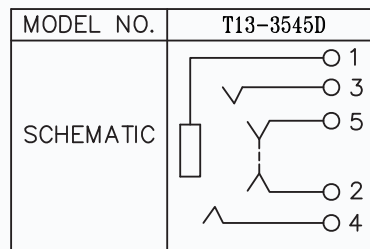

APPD.	DESCRIPTIONS OF REVISION

<b>TOLERANCE</b> UNLESS SPECIFIED
WITHIN 1.5mm : ±0.1mm
OVER 1.5mm : ±0.2mm

THESE DRAWINGS AND SPECIFICATIONS ARE THE PROPERTY OF DONGGUAN TIANDU ELECTRONICS CO.,LTD. AND SHALL NOT BE REPRODUCED, COPIED OR USED IN ANY MANNER WITHOUT THE PRIOR WRITTEN CONSENT OF DONGGUAN TIANDU ELECTRONICS CO., LTD.

<b>TITLE :</b> 3.5mm PHONE JACK
<b>MODEL:</b> T13-3545D
<b>CMTDDZ</b> 东莞市田都电子有限公司
DONGGUAN TIANDU ELECTRONICS CO.,LTD.

<b>UNIT :</b> mm	<b>DRWG NO.:</b> CMTDDZ-T13-3545-00
<b>SCALE:</b> 3:1	<b>DWN.</b> ERIC 2013-6-17
<b>CHK'D</b> MAIKO 2013-6-17	<b>APPD.</b> Coco 2013-6-17