

CAD FILE:

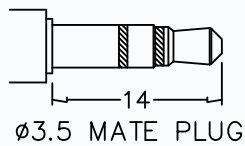
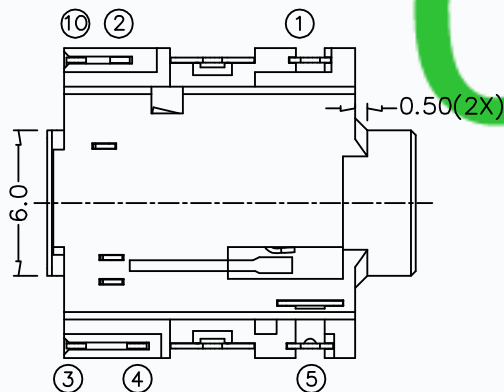
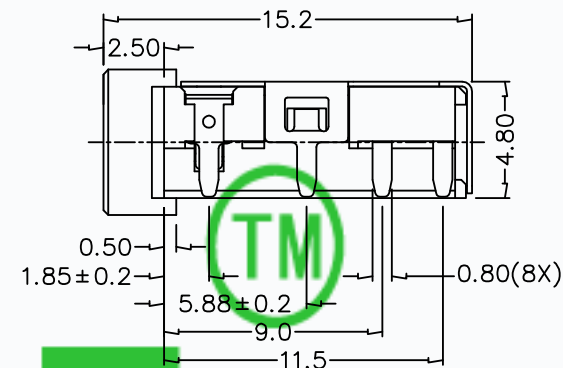
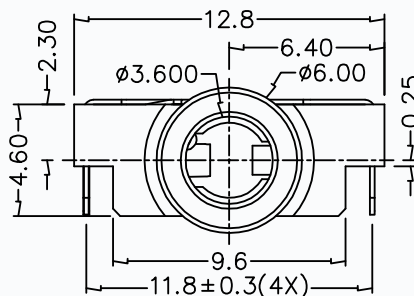
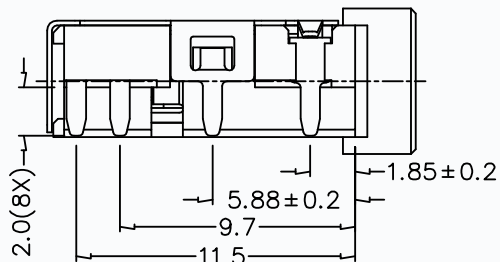
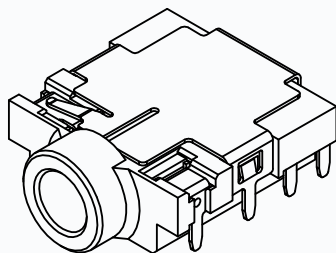

CMTDDZ

*** MATERIAL**

- TERMINAL 1 : COPPER ALLOY
- TERMINAL 2 : COPPER ALLOY
- TERMINAL 3 : COPPER ALLOY
- TERMINAL 4 : COPPER ALLOY
- TERMINAL 5 : COPPER ALLOY
- TERMINAL 10 : COPPER ALLOY
- SHIELD : COPPER ALLOY
- HOUSING : PA6T

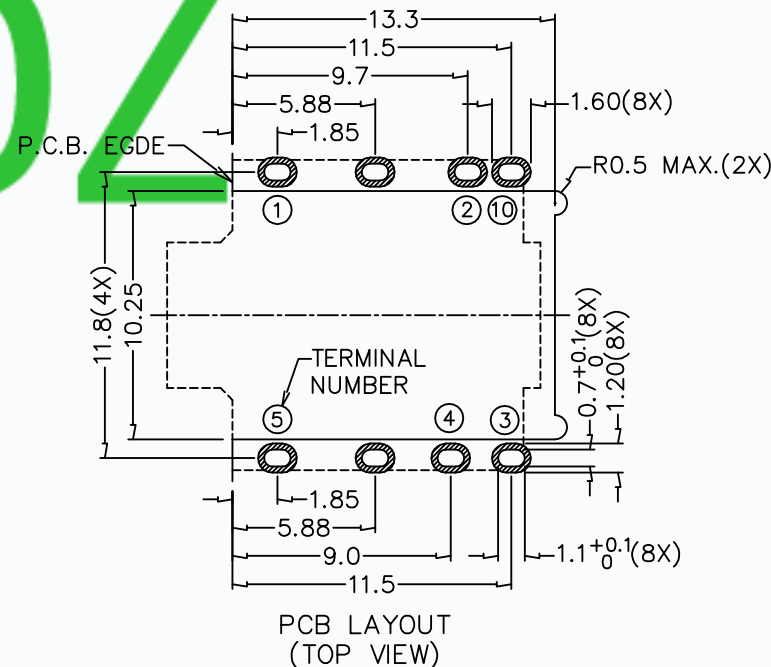

MODEL NO.	T13-3519D
SCHEMATIC	

APPD.	DESCRIPTIONS OF REVISION	TOLERANCE UNLESS SPECIFIED WITHIN 1.5mm : ±0.1mm OVER 1.5mm : ±0.2mm	THESE DRAWINGS AND SPECIFICATIONS ARE THE PROPERTY OF DONGGUAN TIANDU ELECTRONICS CO.,LTD. AND SHALL NOT BE REPRODUCED, COPIED OR USED IN ANY MANNER WITHOUT THE PRIOR WRITTEN CONSENT OF DONGGUAN TIANDU ELECTRONICS CO., LTD.	TITLE : 3.5mm SMD PHONE JACK		UNIT : mm	DRWG NO.: CMTDDZ-T13-3519D-00		
				MODEL: T13-3519D		SCALE: 3:1	DWN.	ERIC	2013-6-17
				CMTDDZ 东莞市田都电子有限公司 DONGGUAN TIANDU ELECTRONICS CO.,LTD.		APPD.	Coco	2013-6-17	