

CAD FILE:

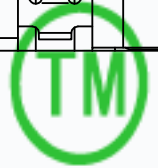

CMTDDZ

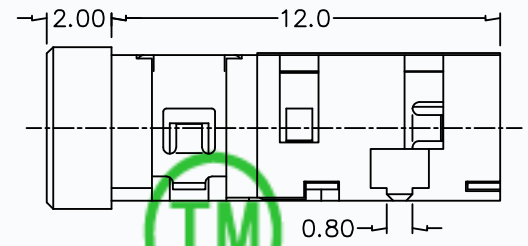
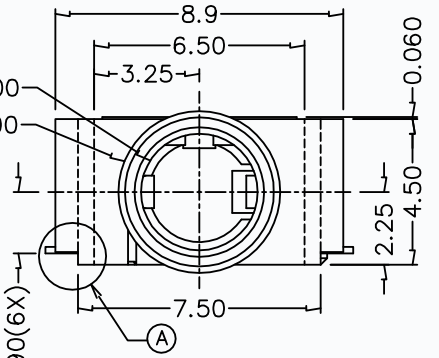
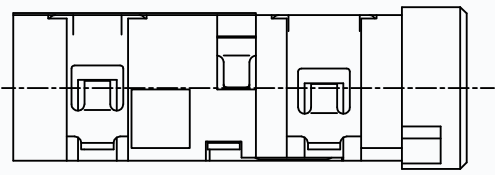
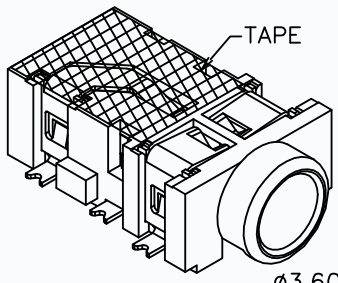
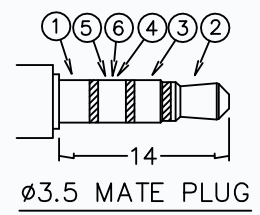
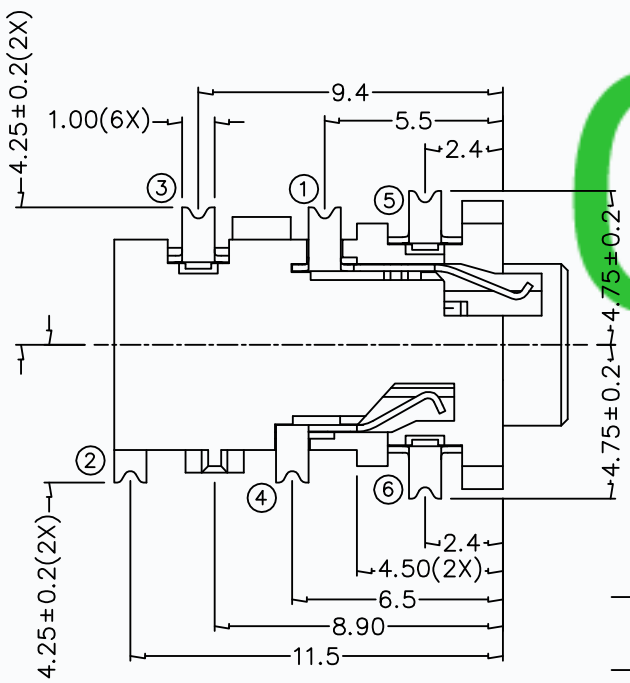

COPLANARITY 0.1

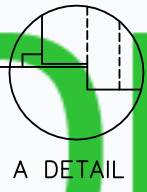

*** MATERIAL**

- TERMINAL 1 : COPPER ALLOY
- TERMINAL 2 : COPPER ALLOY
- TERMINAL 3 : COPPER ALLOY
- TERMINAL 4 : COPPER ALLOY
- TERMINAL 5 : COPPER ALLOY
- TERMINAL 6 : COPPER ALLOY
- HOUSING : PA6T
- TAPE : POLYIMIDE

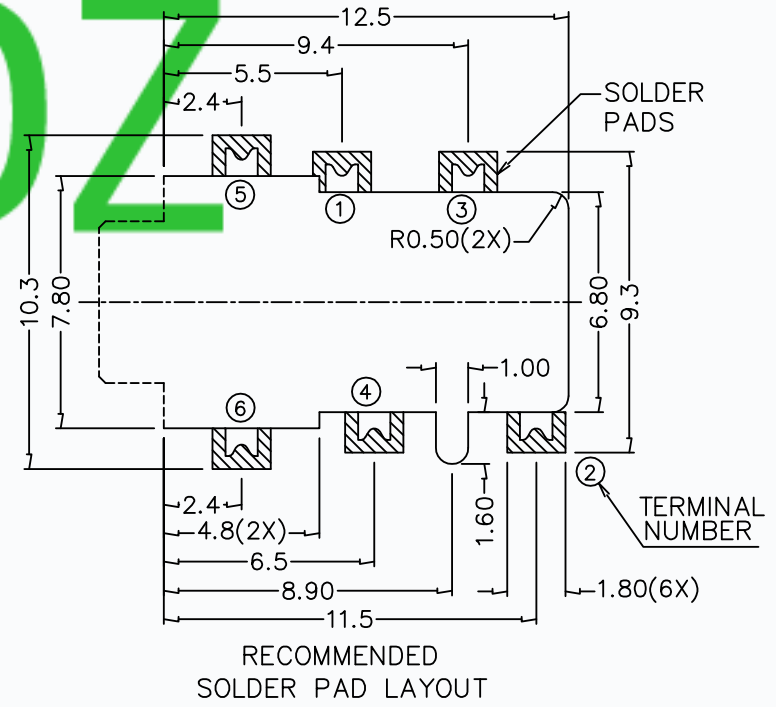
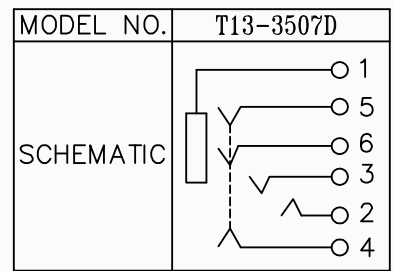

APPD.	DESCRIPTIONS OF REVISION

TOLERANCE UNLESS SPECIFIED
 WITHIN 1.5mm : ±0.1mm
 OVER 1.5mm : ±0.2mm

THESE DRAWINGS AND SPECIFICATIONS ARE THE PROPERTY OF DONGGUAN TIANDU ELECTRONICS CO.,LTD. AND SHALL NOT BE REPRODUCED, COPIED OR USED IN ANY MANNER WITHOUT THE PRIOR WRITTEN CONSENT OF DONGGUAN TIANDU ELECTRONICS CO., LTD.

TITLE : 3.5mm SMD PHONE JACK
MODEL: T13-3507D
CMTDDZ 东莞市田都电子有限公司
 DONGGUAN TIANDU ELECTRONICS CO.,LTD.

UNIT : mm	DRWG NO.: CMTDDZ-T13-3507D-00
SCALE: 3:1	DWN. ERIC 2013-6-17
APPD. Coco	CHK'D MAIKO 2013-6-17
	APPD. Coco 2013-6-17