

CAD FILE:

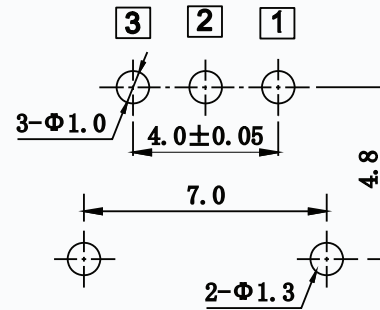
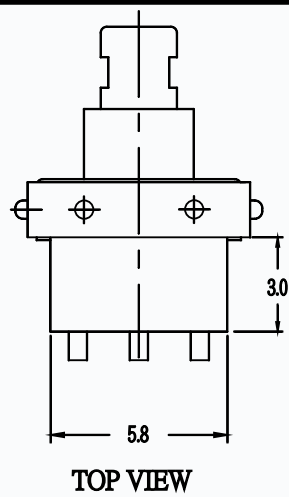
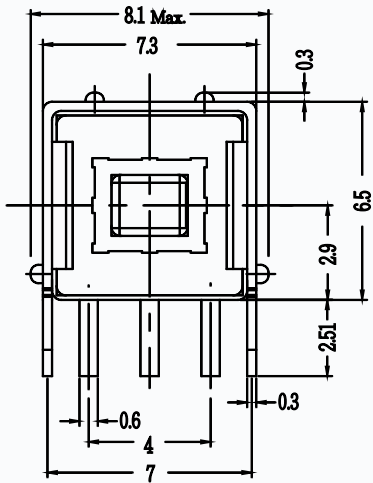

P. C. B LAYOUT

SCHMATIC

FREE

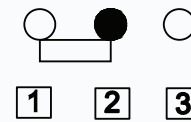

PUSH

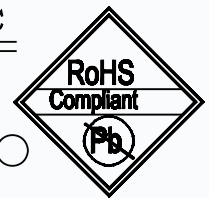
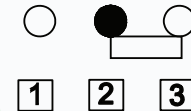

OPERATING MODEL:

SELF-LOCK:T5-58F042D-L
Non-LOCK:T5-58F042D-NL

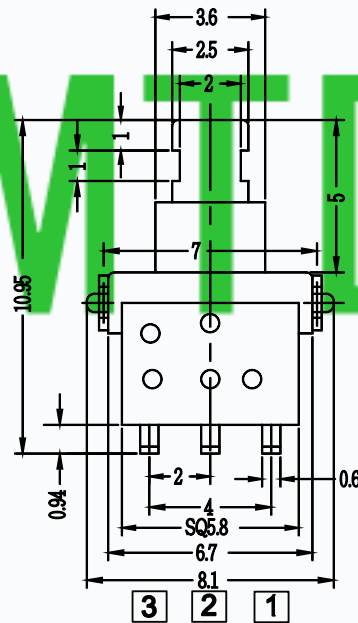
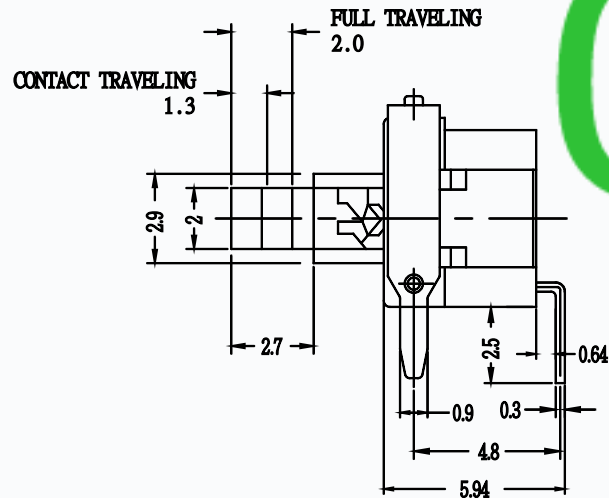

SPECIFICATIONS

Rating	0.1A 30V DC
CIRCUIT	1P-2T
Timing	NON-SHORTING
Travel	FULL:2.0mm
	LOCK:1.3mm
Operating Force	230gf ± 50gf
Operating Life	10,000 cycles

8	STICK	SUS	1	NATURAL
7	SPRING	SUS	1	NATURAL
6	FRAME	SUS	1	SN PLATED
5	TERMINAL	BRASS STRIP	3	Ag PLATED
4	CASE	PPA	1	BLACK
3	COVER	PPA	1	BLACK
2	CONTACT PIECE	PBS C5210R-EH	1	Ag CLAD
1	KNOB	PPA	1	WHITE
NO.	PARTS	MATERIALS	Q'TY	FINISH

TOLERANCE UNLESS SPECIFIED		THESE DRAWINGS AND SPECIFICATIONS ARE THE PROPERTY OF DONGGUAN TIANDU ELECTRONICS CO.,LTD. AND SHALL NOT BE REPRODUCED, COPIED OR USED IN ANY MANNER WITHOUT THE PRIOR WRITTEN CONSENT OF DONGGUAN TIANDU ELECTRONICS CO., LTD		DESCRIPTIONS OF REVISION		APPD.
WITHIN 1.5mm : ±0.1mm OVER 1.5mm : ±0.2mm				TITLE : PUSH SWITCH		UNIT : mm
MODEL: SEE TABLE		SCALE: 3:1	DWN.	ERIC	2013-6-17	
CMTDDZ 东莞市田都电子有限公司		APPD.	CHK'D	MAIKO	2013-6-17	
DONGGUAN TIANDU ELECTRONICS CO.,LTD.		APPD.		Coco	2013-6-17	