

REV.	BRAND	DESCRIPTION	DESIGN	DATE
B	CMTDDZ	NEW		

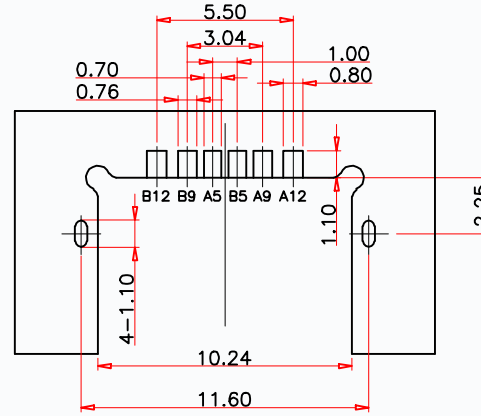
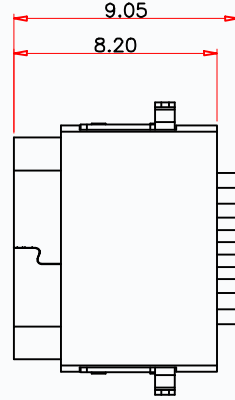
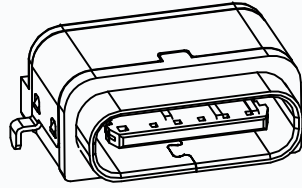
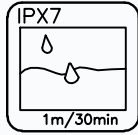

RECOMMENDED P.C.B. LAYOUT  
TOLERANCE UNSPECIFIED ±0.05mm

NOTES:  
SPECIFICATION:

- CURRENT RATING: 3.0A MAX
- VOLTAGE: 100 VAC
- TEMPERATURE RANGE: -30 °C ~ 85 °C
- CONTACT RESISTANCE: 40 MILLIONHM MAX
- INSULATION RESISTANCE: 100 MEGOHMS MIN.
- INSERTION FORCE : 5N~20N
- UNMATING FORCE: 8N~20N
- DURABILITY: 10,000 CYCLES
- WATER PROOFNESS: THIS PRODUCT IS BASED ON IPX7.

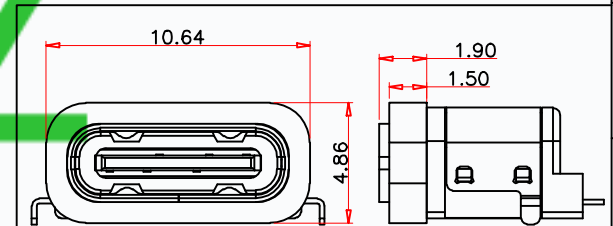
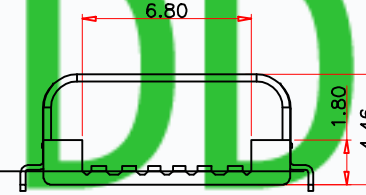
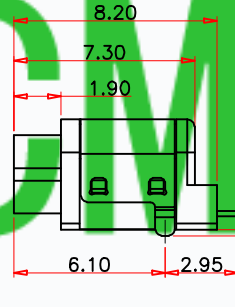
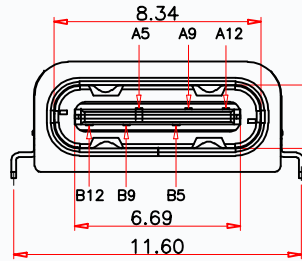
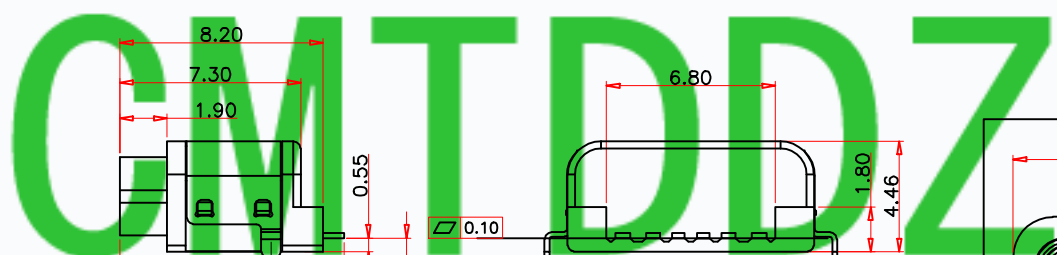
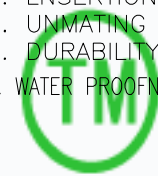

加防水圈示意图

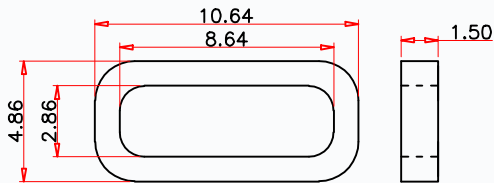

建议的胶圈尺寸

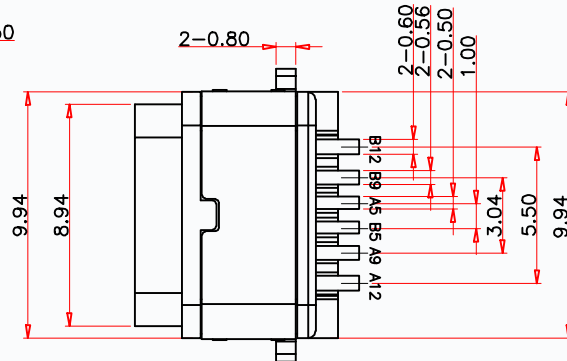

5	SHELL	STAINLESS STEEL	NI Plated	1PCS
4	SHIELDING PLATE	STAINLESS STEEL	NI Plated	1PCS
3	CONTACT	COPPER ALLOY	TIN/Au/NI Plated	1SET
2	SHELL HOUSING	HIGH TEMPERATURE PLASTIC	BLACK	1PCS
1	HOUSING	HIGH TEMPERATURE PLASTIC	BLACK	1PCS
NO.	DESCRIPTION	MATERIAL	REMARKS	QTY

东莞市田都电子有限公司  
DONGGUAN TIANDU ELECTRONIC CO., LTD

USB C F单排沉板6P两脚插板防水型母座

A5	CC1	B12	GND
A9	VBUS	B9	VBUS
A12	GND	B5	CC2
PIN	SIGNAL NAME	PIN	SIGNAL NAME

X. ±0.50	X.* ±2*	UNITS mm	TITLE: <b>USB C F单排沉板6P两脚插板防水型母座</b>	DWG NO.: T11-06CB11		
.X ±0.30	.X* ±1*					
.XX ±0.10	.XX* ±0.5*	FINISH /			APPD:	SCALE SHEET REV. 1/1 1/1 A1
.XXX ±0.05					CHKD:	
THESE DRAWINGS AND SPECIFICATIONS ARE THE PROPERTY OF DONGGUAN TIANDU ELECTRONICS CO.,LTD. AND SHALL NOT BE REPRODUCED, COPIED OR USED IN ANY MANNER WITHOUT THE PRIOR WRITTEN CONSENT OF DONGGUAN TIANDU ELECTRONICS CO., LTD			Q'TY /	DR:		